

Electronic Controls

Low Water Cutoff

For accurate and dependable boiler protection, our Low Water Cutoff (LWCO) features the simplicity, reliability and unmatched quality you've come to expect from Taco Electronic Controls. The LWCO is a probe style, microprocessor based control that detects the fluid level in hot water and steam boilers. Patented signal processing technology, external LEDs and simplified wiring make installation and testing a snap.



Application

The Taco LWCO provides reliable protection for all types of boilers, from small residential hot water boilers to large industrial steam boilers. The boiler's minimum safe operating water level is specified by each manufacturer. Should the water level dip below that specified level, heat will accumulate quickly causing significant damage to the boiler and a potential external safety hazard. The Taco LWCO prevents this hazard from occurring. The LWCO can be used as a primary or secondary low water cutoff on steam boilers up to 250 psi, a primary limit control on hot water boilers or to protect pumps from running dry in condensate receiver tank applications. The LWCO can also activate alarm systems or automatic water feeders.

Probe Style LWCO

A probe uses the boiler's water to complete an electrical circuit. As long as water covers the probe, the electronic circuit will be maintained. If the water level drops below the probe, the circuit is broken, shutting down the burner and protecting the boiler.

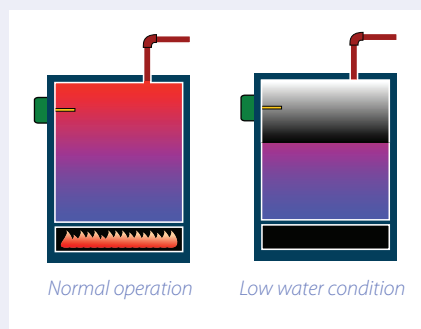

In a low water situation, if the burner continues to fire, damage can occur to the boiler and create a potential disaster. A Taco Low Water Cutoff turns off the burner and signals that a low water situation has occurred.

Worry Free Operation

Every LWCO has been upgraded to incorporate our patented signal processing technology to deliver the best low water protection available. It's so smart it will even tell you when the probe should be cleaned, eliminating the need for yearly maintenance.

Simplified Installation & Wiring

The plug n' play wiring harness for 24 VAC or tri-barrier terminals for 120 VAC wiring makes meeting code, including CSD-1, a snap.

Confidence

A test button verifies that the wiring and installation was done correctly before leaving the job. LED lights eliminate the guess work on service calls by identifying if the cause of the low water condition was a dirty probe or lack of water.

Selection Made Easy

The LTR, LTA-2 and LF Series of Low Water Cutoffs match the safety and installation requirements of any style system while featuring the simplicity, reliability and unmatched quality you've come to expect from Taco Electronic Controls.

Seamless Integration

Pairs perfectly with the Taco Electric Water Feeder to maintain safe water content in the boiler. See Taco Catalog #100-36 to see all of its advanced and patent pending features.

LTR(M)

The LTR is a 1-piece, sealed design for use with residential hot water boilers. The LTR is available in Auto Reset and Manual Reset versions; complete with a test button, LED lights and a plug-in 24 VAC wiring harness so you can meet code while having the confidence the control was wired correctly the first time.

LTA-2

The LTA-2 models are used on smaller hot water boilers (usually under 400,000 BTU). Available in 24 and 120 VAC auto reset models, the LTA-2 has a compact full metal enclosure with direct probe mounting, a test button, external LED lights and easy-to-wire tri-barrier terminals. Built with the same patented signal processing technology as the LTR, the LTA-2 is a great solution for upgrading the safety of current systems or when traditional 120 VAC hard wiring is required.

LF

The LF model is the ultimate LWCO control for use with hot water or steam boilers. The LF uses Taco's patented DualVision® technology to know the difference between foam, water, and even probe buildup. So unlike the

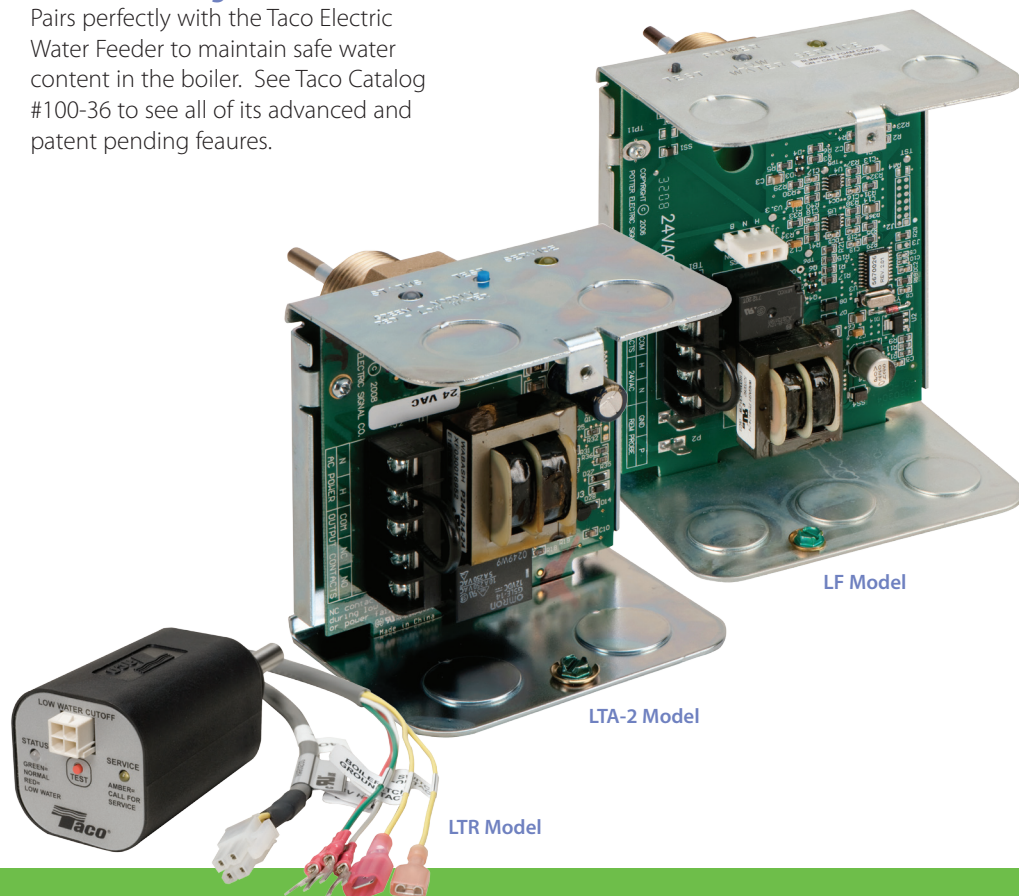

competition, the LF won't shut down your boiler on a false low water condition due to a dirty probe, or shut down every 10 minutes to check for proper water level. You can now run your steam boiler flat out for a significant gain in efficiency and operational safety.

By processing and comparing two separate signals coming back through the standard probe, the DualVision® technology automatically determines the required delay on make (DOM) and delay on break (DOB) settings for any style steam boiler under any system conditions. The LF's patented smarts means no more dip switches to set or dials to program. External LEDs and a test button verify that everything is installed and wired correctly before you leave the job. You can even wire in an alarm or electric water feeder.

The LF Series is available in 24 or 120 VAC models, automatic or manual reset models, 1/2" and 3/4" NPT process connection sizes and a number of probe lengths to match your job requirements.

Patented DualVision® Technology

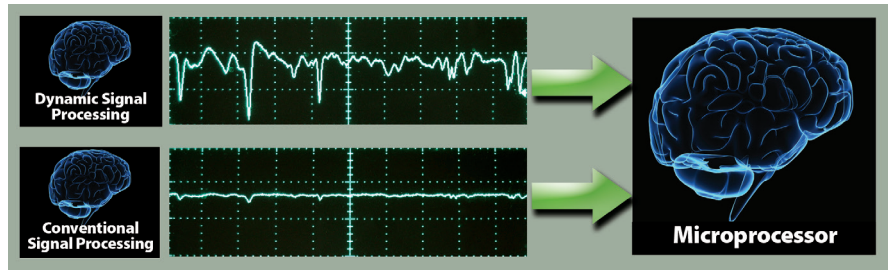

Feature Comparisons of LF, LTA-2 and LTR(M) Models:

Feature	LF	LTA-2	LTR
120 VAC	X	X	
24 VAC	X	X	X
Automatic Reset	X	X	X
Manual Reset	X		X
Foam Compensating	X		
Automatic Delay on Make (DOM)	X		
Automatic Delay on Break (DOB)	X		
Direct Probe to Control Connection	X	X	X
NEMA 4 Remote Probe	X		
Extended Length Remote Probes	X		
Steam Applications	X		
Hot Water Boiler Applications	X	X	X
External LEDs	X	X	X
Test Button	X	X	X
Service LED	X	X	X
Tri-barrier Terminal Blocks	X	X	Molex
CSD-1 Compliant	X	X	X
Listings and Approvals	UL, CUL, FM	UL, CUL	UL, CUL
Probe Connections	1/2" & 3/4" NPT	3/4" NPT	3/4" NPT
Electrical Knock-outs	Five	Four	N/A
Made in the USA	X	X	X

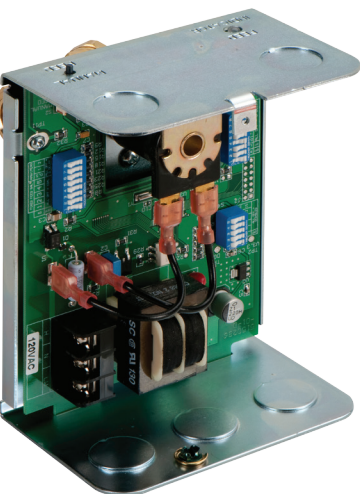

Electric Water Feeder

LF Model Ordering

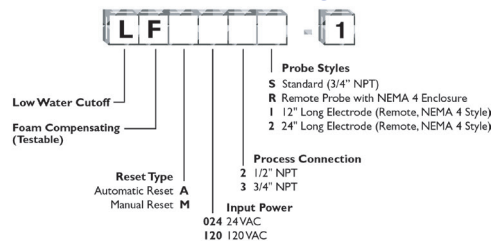

LTA-2 Model Ordering

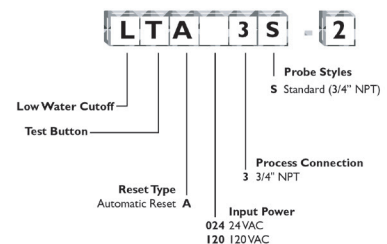

LTR Model Ordering

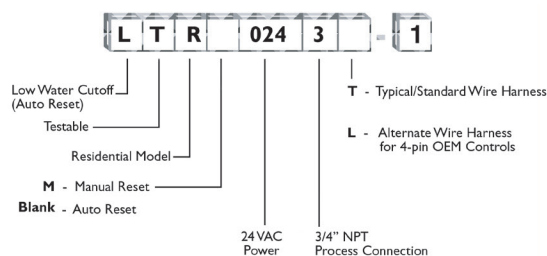

Electronic Water Feeder Ordering

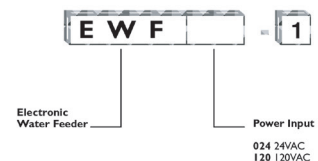

Low Water Cutoff Submittal Data Information

Submittal Data # 101-081
Supersedes: 06/26/13

Effective: 10/01/17

Listings/Approvals

UL GUIDE (MBPR) for Limit Controls per UL Standard 353 Limit Controls
UL GUIDE (MBPR7) Controls, Limit Certified for Canada CSA Standard C22.2
UL GUIDE (MCUR2) for Electrode Assemblies – Component (remote probes)
FM Approved (LF only)
Fully compliant with CSD-1 requirements

Material of Construction

LTA-2 and LF Control Unit: NEMA Type 1 (For indoor use only). Formed sheet metal with powder coat/plated finish enclosure, knock-outs for 1/2" conduit fittings.

LTR Unit: UL 94 V0 rated engineered plastic enclosure

Remote Probe: NEMA Type 4. Drawn sheet metal with powder coat/plated finish enclosure. Opening for 1/2" conduit fitting.

All models are not for use in hazardous locations

Performance Data

Category	LF Model	LTA-2 Model	LTR Model
Maximum Pressures Steam	250 psi (17.6 kg/cm ²)	NA	N/A
Maximum Pressures Hot Water	250 psi (17.6 kg/cm ²) @250°F (121°C)	250 psi (17.6 kg/cm ²) @250°F (121°C)	160 psi (11.2 kg/cm ²) @ 250°F (121°C)
Maximum Ambient Temp.	150°F (66°C)	150°F (66°C)	120°F (49°C)
Delays	Automatic	N/A	N/A
Probe Sensitivity	20K Ohms, extended operation to 40K Ohms	20K Ohms, extended operation to 40K Ohms	20K Ohms, extended operation to 40K Ohms
Control Power Consumption	3VA @ 120VAC, 3VA @ 24VAC	2.8VA @ 120VAC, 2.8VA @ 24VAC	1.5VA @ 24VAC
Input Supply Voltage	120VAC, 24VAC*	120VAC, 24VAC*	24VAC*

*24VAC supplied by a Class 2 power source

Model LF Dimensions

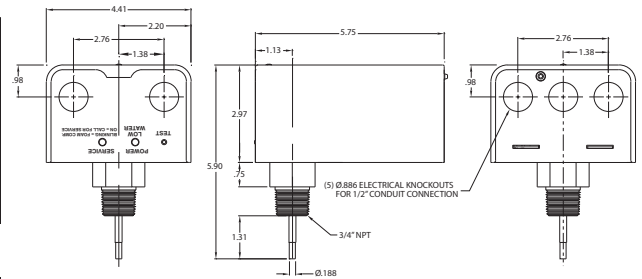

Model LTA-2 Dimensions

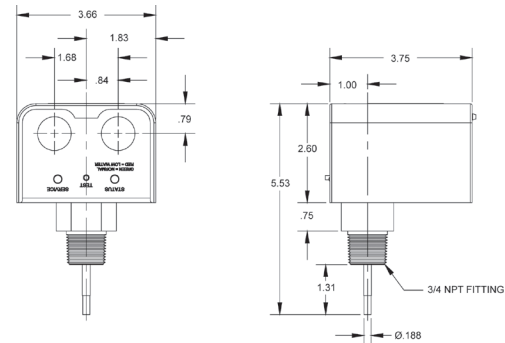

Model LTR Dimensions

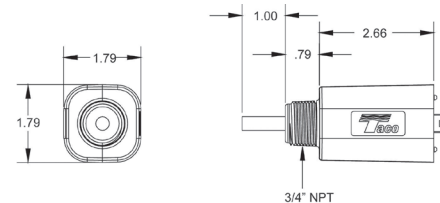

Remote Probe Dimensions

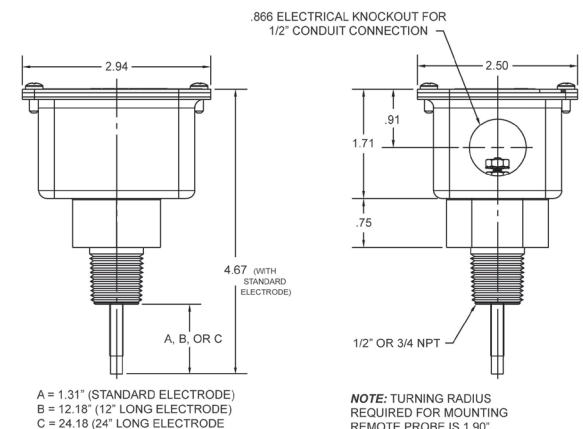

Taco Inc., 1160 Cranston Street, Cranston, RI 02920 / (401) 942-8000 / Fax (401) 942-2360
Taco (Canada) Ltd., 8450 Lawson Road, Unit #3, Milton, Ontario L9T 0J8 / (905) 564-9422 / Fax (905) 564-9436