



**McDonnell & Miller**  
a xylem brand

**INSTRUCTION MANUAL**

MM-323H



**Series WFE Uni-Match®  
Electric Water Feeder**

**Applications:**

For use on boilers with mechanical (float type) or electronic (probe type) LWCO's.



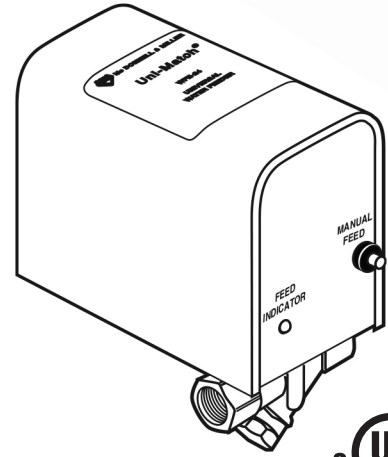

The Uni-Match® water feeder is available in either 24 or 120 volt and all models feature a manual feed button. Field selectable dwell/feed cycles allow condensate to return to the boiler before feeding, lessening the chance the boiler will be overfed or flood.



Uni-Match



**WARNING**

	<ul style="list-style-type: none"> <li>• Before using this product read and understand instructions.</li> <li>• Save these instructions for future reference.</li> <li>• All work must be performed by qualified personnel trained in the proper application, installation, and maintenance of plumbing, steam, and electrical and/or systems in accordance with all applicable codes and ordinances.</li> </ul>
	<ul style="list-style-type: none"> <li>• To prevent electrical shock, turn off the electrical power before making electrical connections.</li> <li>• Boiler manufacturer schematics should always be followed. In the event that the boiler manufacturer's schematic does not exist, or is not available from the boiler manufacturer, refer to the schematics provided in this document.</li> </ul>
	<ul style="list-style-type: none"> <li>• To prevent water damage check to make sure there is adequate floor drainage capacity. Check all components in the system to insure that they will not leak in the event of an overfeed condition.</li> <li>• After installation, check for proper operation of all of the limit and operating controls, before leaving the site.</li> </ul>
	<ul style="list-style-type: none"> <li>• This product can expose you to chemicals including Lead, which is known to the State of California to cause cancer and birth defects or other reproductive harm. For more information go to: <a href="http://www.P65Warnings.ca.gov">www.P65Warnings.ca.gov</a>.</li> <li>• Previous controls should never be installed on a new system. Always install new controls on a new boiler or system.</li> </ul>
	<p>Failure to follow this warning could cause property damage, personal injury or death.</p> <p><b>CAUTION:</b></p> <ul style="list-style-type: none"> <li>• A more frequent replacement interval may be necessary based on the condition of the unit at time of inspection. McDonnell &amp; Miller's warranty is one (1) year from date of installation or two (2) years from the date of manufacture.</li> </ul>

# SPECIFICATIONS

**Maximum Water Pressure:**

150 psi (10.5 kg/cm<sup>2</sup>)

**Maximum Boiler Pressure:**

15 psi (1 kg/cm<sup>2</sup>)

**Pipe Connections:**

3/8" NPT (sweat adapters included for connection to 1/2" copper pipe)

**Flow Data:**

2 gpm (7.6 lpm) standard

Orifices included to change feed rate to 1 gpm (3.8 lpm) or 4 gpm (15.1 lpm)

## Electrical Ratings

Model	Voltage**	Power Consumption*
WFE-24	24VAC	15VA
WFE-120	120VAC	20VA

\* During Feed Cycle

\*\* 50/60 Hz

**Maximum Water Temperature:**

120°F (49°C)

**Maximum Ambient Temperature:**

100°F (38°C)

### Dwell/Feed Selector Switch

The water feeder has a DIP type switch block with four on/off switches. Each switch has a specific dwell/feed cycle which is activated upon receiving a signal from the LWCO. The feeder will be deactivated when the LWCO is satisfied or if the dwell/feed period has been exceeded.

### Manual Feed

There is a manual feed button which when pressed will add water to the boiler.

### Multi-Color LED

A multi-color LED indicates status during operation, incorrect switch selection and when dwell/feed cycle has been exceeded.

### Dwell/Feed Cycle Limit

The feeder will stop feeding water whenever the selected dwell/feed cycle time has been exceeded and the LWCO is still sending a signal.

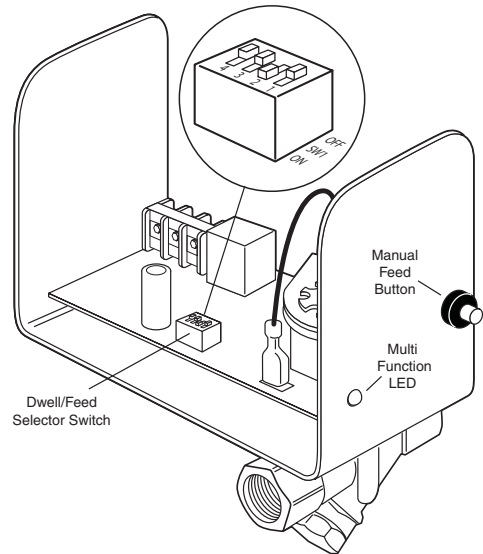

## STEP 1 - Installation

- 1 a. Control must be installed within eyesight of boiler.
- b. Clearance must be provided on all sides to service control.
- c. Unit must be installed in a horizontal pipe in an upright position.
- d. Arrow on feeder must point in the direction of flow into the boiler.
- e. Install isolation valves and unions on the inlet and outlet piping for easier trouble shooting and repair/replacement.
- f. Install manual fill valve and bypass line for removal while the boiler is in service.

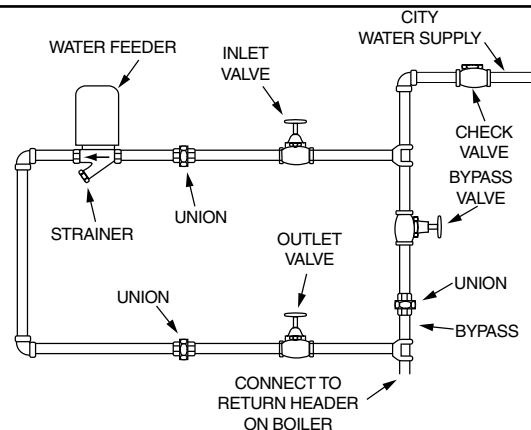

2. Water feeders are shipped from the factory equipped for a 2 gpm feed rate. A separate kit with instruction sheet and field installable orifices for 1 gpm and 4 gpm feed rates is included. If the alternate feed rates are required, refer to the instruction sheet provided with the kit for orifice replacement.

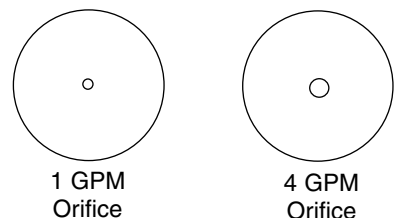

## STEP 2 - Electrical Installation

### IMPORTANT

Boiler manufacturer schematics should be followed. In the event that the boiler manufacturer's schematic does not exist, or is not available from the boiler manufacturer, refer to the schematics provided in this document.

### WARNING



To prevent electrical shock, turn off the electrical power before making electrical connections.  
Failure to follow this warning could cause property damage, personal injury or death.

### Terminal Connections

For all wire connections to the terminal block (M).

1. Strip about 1/3" (8.5 mm) of insulation from the wire.
2. Loosen the terminal screw (N) but DO NOT REMOVE. Move the wire clamping plate (P) back until the plate touches the back side of the screw head.
3. Insert the stripped end of the wire under the wire clamping plate (P) and securely tighten the terminal screw (N).

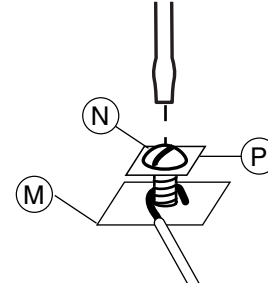

### WARNING

Do not use automatic water feeders with manual reset LWCO's. Failure to follow this warning could cause flooding, property damage, personal injury or death.

### NOTE

Unless otherwise noted, water feeder voltage should be the same as the LWCO and burner circuit voltage.

### NOTE

Before wiring water feeder, operate boiler and check all safety devices.

### NOTE

Wire must be 18 AWG (min) or as required by local code. Wire insulation rating must be at least 167°F (75°C)

### Wiring Diagram Selection Chart

Based on the water feeder and low water cut-off combination you are installing, select proper wiring diagram and proceed to that page.

Feeder Model	LWCO Model	Diagram Number	Page
WFE-24	PSE-802 with burner wiring harness	1	4
WFE-24	PSE-802 with burner terminal connections	1	4
WFE-24	PS-802 with burner wiring harness	1	4
WFE-24	PS-802 with burner terminal connections	1	4
WFE-24	67 w/24 volt burner circuit	4	4
WFE-24	67 w/120 volt burner circuit	6	4
WFE-24	67G (millivolt burner circuit)	9	5
WFE-120	PS-801 with numbered terminals	2	4
WFE-120	PSE-801 with lettered terminals	3	4
WFE-120	PS-801 with lettered terminals	3	4
WFE-120	67 w/24 volt burner circuit	7	4
WFE-120	67 w/120 volt burner circuit	5	4
WFE-120	67G (millivolt burner circuit)	8	5
WFE-24	Hydrolevel 400	10	5
WFE-24	Hydrolevel CG400	11	5
WFE-120	Hydrolevel 450	12	5
WFE-120	Hydrolevel CG450	13	5
WFE-120	Hydrolevel CGT450	14	6
WFE-24	Honeywell LWCO (24 volt)	15	6
WFE-120	Honeywell LWCO (120 volt)	16	6
WFE-24	TACO LWCO (24 volt)	18	6
WFE-120	TACO LWCO (120 volt)	17	6

## Wiring Diagram Legends

1. **—** Bold lines indicate action to be taken in Step shown.
2. **—** Grey lines indicate existing wiring.

### Diagram 1

WFE-24 / PS-802 / UNIMATCH WATER FEEDER

- Connect wire from terminal 'N' of water feeder to terminal 'N' on LWCO.
- Connect wire from terminal 'H' of water feeder to terminal 'H' on LWCO.
- Connect wire from terminal 'W' of water feeder to terminal 'W' on LWCO.

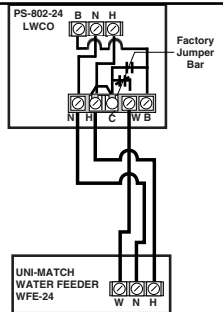

### Diagram 2

WFE-120 / PS-801-LWCO with numbered terminals

- Connect wire from terminal 'N' of water feeder to terminal '2' on LWCO.
- Connect wire from terminal 'H' of water feeder to terminal '1' on LWCO.
- Connect wire from terminal 'W' of water feeder to terminal '4' on LWCO.

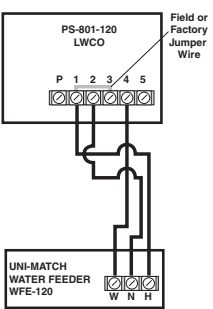

### Diagram 3

WFE-120 / PS-801/PSE-801 UNIMATCH WATER FEEDER with lettered terminals

- Connect wire from terminal 'N' of water feeder to terminal 'N' on LWCO.
- Connect wire from terminal 'H' of water feeder to terminal 'H' on LWCO.
- Connect wire from terminal 'W' of water feeder to terminal 'W' on LWCO.

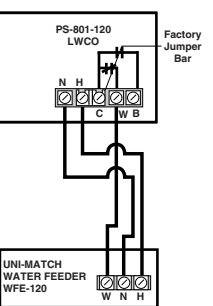

### Diagram 4

WFE-24 / 67 with 24 volt burner circuit

- Connect wire from terminal 'N' of water feeder to 'Neutral' wire of burner circuit.
- Connect wire from terminal 'H' of water feeder to terminal '2' on LWCO.
- Connect jumper wire connecting terminals '2' and '3' of LWCO.
- Connect wire from terminal 'W' of water feeder to terminal '4' on LWCO.

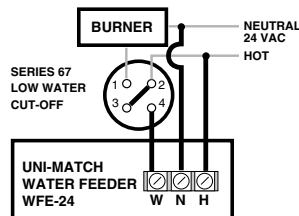

### Diagram 5

WFE-120 / 67 with 120 volt burner circuit

- Connect wire from terminal 'N' of water feeder to 'Neutral' wire of burner circuit.
- Connect wire from terminal 'H' of water feeder to terminal '2' on LWCO.
- Connect jumper wire connecting terminals '2' and '3' of LWCO.
- Connect wire from terminal 'W' of water feeder to terminal '4' on LWCO.

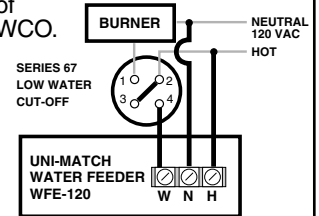

### Diagram 6

WFE-24 / 67 with 120 volt burner circuit

- Install wire from burner circuit 'Neutral' wire to the transformer input 'Neutral' terminal.
- Install wire from burner circuit 'Hot' wire to the transformer input 'Hot' terminal.
- Install wire from transformer output 'Neutral' terminal to terminal 'N' on the water feeder.
- Install wire from terminal 'W' on the water feeder to terminal '4' on the low water cut-off.
- Install wire from transformer output 'Hot' terminal to terminal 'H' on water feeder and terminal '3' on low water cut-off.

**NOTE:** Transformer provided by others.

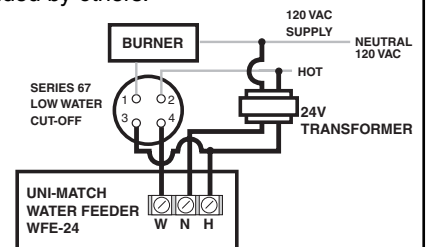

### Diagram 7

WFE-120 / 67 with 24 volt burner circuit

- Install wire from burner circuit 'Neutral' wire to terminal 'N' on water feeder.
- Install wire from burner circuit 'Hot' wire to terminal 'H' on water feeder and terminal '3' on low water cut-off.
- Install wire from terminal 'W' on the water feeder to terminal '4' on the low water cut-off.

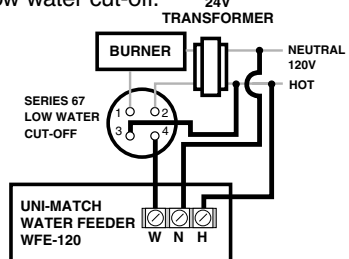

### Diagram 8

WFE-120 / 67 with millivolt burner circuit

- Install wire from 120 volt circuit 'Neutral' wire to terminal 'N' on water feeder.
- Install wire from 120 volt circuit 'Hot' wire to terminal 'H' on water feeder and terminal '3' on low water cut-off.
- Install wire from terminal 'W' on the water feeder to terminal '4' on the low water cut-off.

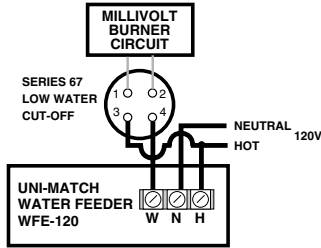

### Diagram 9

WFE-24 / 67 with millivolt burner circuit

- Install wire from 120 volt circuit 'Neutral' wire to the transformer input 'Neutral' terminal.
- Install wire from 120 volt circuit 'Hot' wire to the transformer input 'Hot' terminal.
- Install wire from transformer output 'Neutral' terminal to terminal 'N' on the water feeder.
- Install wire from transformer output 'Hot' terminal to terminal 'H' on water feeder and terminal '3' on low water cut-off.
- Install wire from terminal 'W' on the water feeder to terminal '4' on the low water cut-off.

NOTE: Transformer provided by others.

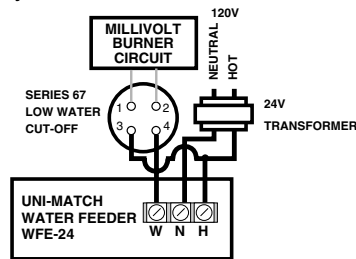

### Diagram 10

WFE-24 / Hydrolevel 400

- Connect wire from terminal 'N' of water feeder to terminal '2' on LWCO.
- Connect wire from terminal 'H' of water feeder to terminal '1' on LWCO.
- Connect wire from terminal 'W' of water feeder to terminal 'A' on LWCO.

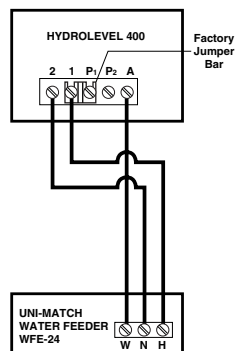

### Diagram 11

WFE-24 / Hydrolevel CG400

- Connect wire from terminal 'N' of water feeder to terminal '2' on LWCO.
- Connect wire from terminal 'H' of water feeder to terminal '1' on LWCO.
- Connect wire from terminal 'W' of water feeder to terminal 'A' on LWCO.

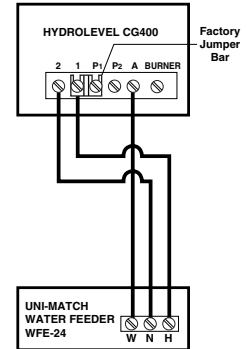

### Diagram 12

WFE-120 / Hydrolevel 450

- Connect wire from terminal 'N' of water feeder to terminal '2' on LWCO.
- Connect wire from terminal 'H' of water feeder to terminal '1' on LWCO.
- Connect wire from terminal 'W' of water feeder to terminal 'A' on LWCO.

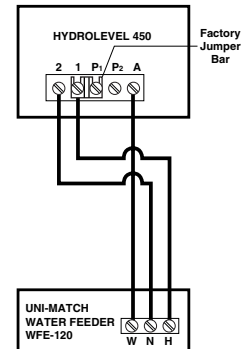

### Diagram 13

WFE-120 / Hydrolevel CG450

- Connect wire from terminal 'N' of water feeder to terminal '2' on LWCO.
- Connect wire from terminal 'H' of water feeder to terminal '1' on LWCO.
- Connect wire from terminal 'W' of water feeder to terminal 'A' on LWCO.

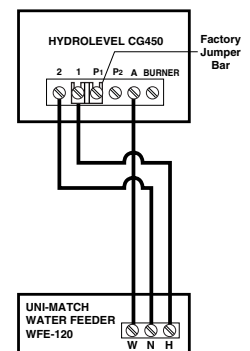

### Diagram 14

WFE-120 / Hydrolevel CGT450

- Connect wire from terminal 'N' of water feeder to terminal '2' on LWCO.
- Connect wire from terminal 'H' of water feeder to terminal '1' on LWCO.
- Connect wire from terminal 'W' of water feeder to terminal 'A' on LWCO.

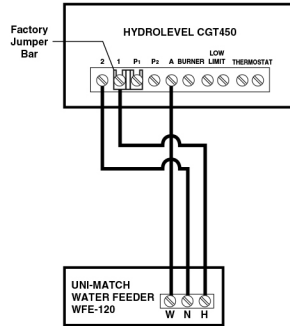

### Diagram 17

WFE-120 / TACO LWCO (120 volt)

- Connect wire from terminal 'N' of water feeder to terminal 'N' on LWCO.
- Connect wire from terminal 'H' of water feeder to terminal 'L' on LWCO.
- Connect wire from terminal 'W' of water feeder to terminal 'NO' on LWCO.

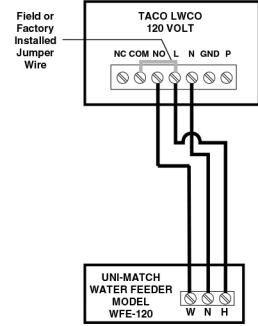

### Diagram 15

WFE-24 / Honeywell LWCO (24 volt)

- Connect wire from terminal 'N' of water feeder to terminal 'T2' on LWCO.
- Connect wire from terminal 'H' of water feeder to terminal 'T1' on LWCO.
- Connect jumper wire from terminal 'T1' to terminal 'A' on the low water cut-off.
- Connect wire from terminal 'W' of water feeder to terminal 'A' on LWCO.

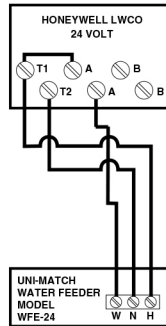

### Diagram 18

WFE-24 / TACO LWCO (24 volt)

- Connect wire from terminal 'N' of water feeder to terminal 'N' on LWCO.
- Connect wire from terminal 'H' of water feeder to terminal 'L' on LWCO.
- Connect wire from terminal 'W' of water feeder to terminal 'NO' on LWCO.

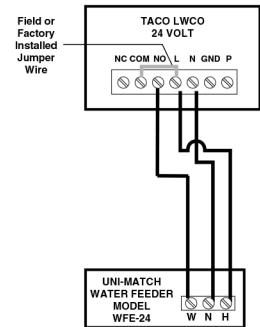

### Diagram 16

WFE-120 / Honeywell LWCO (120 volt)

- Connect wire from terminal 'N' of water feeder to terminal 'L2' on LWCO.
- Connect wire from terminal 'H' of water feeder to terminal 'L1' on LWCO.
- Connect jumper wire from terminal 'L1' to terminal 'A' on the low water cut-off.
- Connect wire from terminal 'W' of water feeder to terminal 'A' on LWCO.

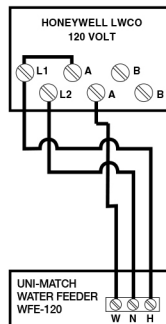

## STEP 3 - Testing

- a. Open the inlet valve (X) and the outlet valve (Y). Check for any leakage. If there are any leaky connections, close the inlet and outlet valves and correct the problem.
- b. Turn the boiler's electric power on and fill it to the manufacturer's recommended normal water level by depressing the red manual feed button (Z) on the water feeder.

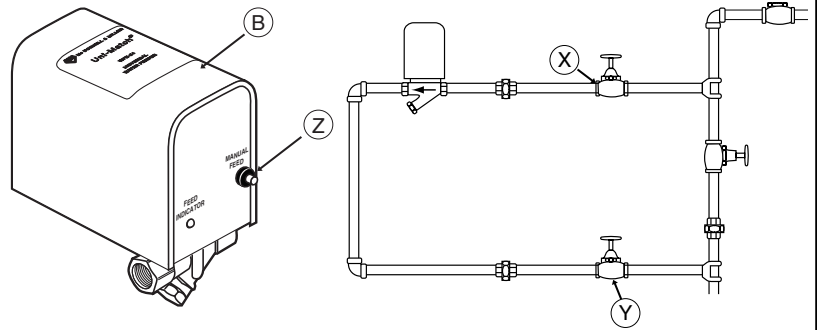

- c. Check the water feeder (B) operation by performing the following steps:

1. Slowly drain water from the boiler.
2. The burner should turn off when the water level drops below the cut-off level of the LWCO, which will activate the water feeder's delay feed cycle.

### **WARNING**

**If burner does not turn off when water level falls below level of LWCO, turn off power to boiler and check operation of LWCO.**

3. Feeder should turn on to feed water to boiler after delay period has expired.  
**NOTE:** Delay period is determined by position of selector. Unit is shipped with switch in Position 2. Refer to chart on page 8 for alternate settings.
4. Feeder will be deactivated when water level is restored to level as determined by LWCO.  
**NOTE:** McDonnell & Miller Series PSE LWCO's have a 30 second DOM (Delay on Make) to restore water level in boiler to an appropriate level without overfeeding. Consult other manufacturer's LWCO installation literature for DOM times.
5. Repeat steps to ensure feeder is operating satisfactorily.

### Multi-Color LED

Upon receiving a signal from LWCO (power to terminal 'W') the multi-color LED will indicate the status of the feeder.

LED	Condition	Solution
Flashing Green	Dwell Period -Solenoid Closed	_____
Solid Green	Feed Period -Solenoid Open	_____
Flashing Red	Invalid Feed Cycle Switch Setting	Only one of the switches should be in the 'ON' position.
Solid Red	Dwell/Feed Cycle Exceeded	Check operation of LWCO.

## STEP 3 - Testing

### Dwell/Feed Switches

The unit is shipped with switch 2 'ON' and all other switches on the 'OFF' position.

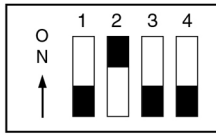

Factory Setting  
Position 2 - ON

Switch Position	Initial Dwell*	Initial Feed*	Dwell/Feed Cycles
1	0	300	1
2	60	60	5
3	30	270	1
4	120	180	1

\*Dwell/Feed Time in Seconds

### Switch Selection Guidelines

- #1 – Should only be used with a float type LWCO such as the M&M Series 67.
- #2 – Satisfactory for most residential steam boiler applications.
- #3 – Shorter initial dwell period suggested for smaller 3 or 4 section boilers.
- #4 – Longer initial dwell period suggested for a period of time immediately after initial boiler installation.

## STEP 4 - Troubleshooting

If the unit fails to feed water as required, perform the following diagnostic checks:

1. Recheck all wiring to ensure proper connections, as specified in these instructions.
2. Check to insure that the integral strainer is clean and free of debris and sediment.
3. Check to ensure proper operation of low water cut-off controls connected to water feeder.

## MAINTENANCE

### SCHEDULE:

- **Inspect the water feeder annually.** Replace it if it is worn, corroded, or if components no longer operate properly.
- **Replace the water feeder every 10 years.** More frequent replacement may be required when severe conditions exist such as rapid switch cycling and surging water levels.
- **Disassemble and carefully clean strainer screen once per heating season.**

#### COMMERCIAL WARRANTY

**Warranty.** For goods sold to commercial buyers, Seller warrants the goods sold to Buyer hereunder (with the exception of membranes, seals, gaskets, elastomer materials, coatings and other "wear parts" or consumables all of which are not warranted except as otherwise provided in the quotation or sales form) will be (i) be built in accordance with the specifications referred to in the quotation or sales form, if such specifications are expressly made a part of this Agreement, and (ii) free from defects in material and workmanship for a period of one (1) year from the date of installation or two (2) years from the date of manufacture, whichever shall occur first, unless a longer period is specified in the product documentation (the "Warranty").

Except as otherwise required by law, Seller shall, at its option and at no cost to Buyer, either repair or replace any product which fails to conform with the Warranty provided Buyer gives written notice to Seller of any defects in material or workmanship within ten (10) days of the date when any defects or non-conformance are first manifest. Under either repair or replacement option, Seller shall not be obligated to remove or pay for the removal of the defective product or install or pay for the installation of the replaced or repaired product and Buyer shall be responsible for all other costs, including, but not limited to, service costs, shipping fees and expenses. Seller shall have sole discretion as to the method or means of repair or replacement. Buyer's failure to comply with Seller's repair or replacement directions shall terminate Seller's obligations under this Warranty and render the Warranty void. Any parts repaired or replaced under the Warranty are warranted only for the balance of the warranty period on the parts that were repaired or replaced. Seller shall have no warranty obligations to Buyer with respect to any product or parts of a product that have been: (a) repaired by third parties other than Seller or without Seller's written approval; (b) subject to misuse, misapplication, neglect, alteration, accident, or physical damage; (c) used in a manner contrary to Seller's instructions for installation, operation and maintenance; (d) damaged from ordinary wear and tear, corrosion, or chemical attack; (e) damaged due to abnormal conditions, vibration, failure to properly prime, or operation without flow; (f) damaged due to a defective power supply or improper electrical protection; or (g) damaged resulting from the use of accessory equipment not sold or approved by Seller. In any case of products not manufactured by Seller, there is no warranty from Seller; however, Seller will extend to Buyer any warranty received from Seller's supplier of such products.

**THE FOREGOING WARRANTY IS EXCLUSIVE AND IN LIEU OF ANY AND ALL OTHER EXPRESS OR IMPLIED WARRANTIES, GUARANTEES, CONDITIONS OR TERMS OF WHATEVER NATURE RELATING TO THE GOODS PROVIDED HEREUNDER, INCLUDING WITHOUT LIMITATION ANY IMPLIED WARRANTIES OF MERCHANTABILITY AND FITNESS FOR A PARTICULAR PURPOSE, WHICH ARE HEREBY EXPRESSLY DISCLAIMED AND EXCLUDED. EXCEPT AS OTHERWISE REQUIRED BY LAW, BUYER'S EXCLUSIVE REMEDY AND SELLER'S AGGREGATE LIABILITY FOR BREACH OF ANY OF THE FOREGOING WARRANTIES ARE LIMITED TO REPAIRING OR REPLACING THE PRODUCT AND SHALL IN ALL CASES BE LIMITED TO THE AMOUNT PAID BY THE BUYER FOR THE DEFECTIVE PRODUCT. IN NO EVENT SHALL SELLER BE LIABLE FOR ANY OTHER FORM OF DAMAGES, WHETHER DIRECT, INDIRECT, LIQUIDATED, INCIDENTAL, CONSEQUENTIAL, PUNITIVE, EXEMPLARY OR SPECIAL DAMAGES, INCLUDING BUT NOT LIMITED TO LOSS OF PROFIT, LOSS OF ANTICIPATED SAVINGS OR REVENUE, LOSS OF INCOME, LOSS OF BUSINESS, LOSS OF PRODUCTION, LOSS OF OPPORTUNITY OR LOSS OF REPUTATION.**

#### LIMITED CONSUMER WARRANTY

**Warranty.** For goods sold for personal, family or household purposes, Seller warrants the goods purchased hereunder (with the exception of membranes, seals, gaskets, elastomer materials, coatings and other "wear parts" or consumables all of which are not warranted except as otherwise provided in the quotation or sales form) will be free from defects in material and workmanship for a period of one (1) year from the date of installation or two (2) years from the product date code, whichever shall occur first, unless a longer period is provided by law or is specified in the product documentation (the "Warranty").

Except as otherwise required by law, Seller shall, at its option and at no cost to Buyer, either repair or replace any product which fails to conform with the Warranty provided Buyer gives written notice to Seller of any defects in material or workmanship within ten (10) days of the date when any defects or non-conformance are first manifest. Under either repair or replacement option, Seller shall not be obligated to remove or pay for the removal of the defective product or install or pay for the installation of the replaced or repaired product and Buyer shall be responsible for all other costs, including, but not limited to, service costs, shipping fees and expenses. Seller shall have sole discretion as to the method or means of repair or replacement. Buyer's failure to comply with Seller's repair or replacement directions shall terminate Seller's obligations under this Warranty and render this Warranty void. Any parts repaired or replaced under the Warranty are warranted only for the balance of the warranty period on the parts that were repaired or replaced. The Warranty is conditioned on Buyer giving written notice to Seller of any defects in material or workmanship of warranted goods within ten (10) days of the date when any defects are first manifest.

Seller shall have no warranty obligations to Buyer with respect to any product or parts of a product that have been: (a) repaired by third parties other than Seller or without Seller's written approval; (b) subject to misuse, misapplication, neglect, alteration, accident, or physical damage; (c) used in a manner contrary to Seller's instructions for installation, operation and maintenance; (d) damaged from ordinary wear and tear, corrosion, or chemical attack; (e) damaged due to abnormal conditions, vibration, failure to properly prime, or operation without flow; (f) damaged due to a defective power supply or improper electrical protection; or (g) damaged resulting from the use of accessory equipment not sold or approved by Seller. In any case of products not manufactured by Seller, however, Seller will extend to Buyer any warranty received from Seller's supplier of such products.

**THE FOREGOING WARRANTY IS PROVIDED IN PLACE OF ALL OTHER EXPRESS WARRANTIES. ALL IMPLIED WARRANTIES, INCLUDING BUT NOT LIMITED TO THE IMPLIED WARRANTIES OF MERCHANTABILITY AND FITNESS FOR A PARTICULAR PURPOSE, ARE LIMITED TO ONE (1) YEAR FROM THE DATE OF INSTALLATION OR TWO (2) YEARS FROM THE PRODUCT DATE CODE, WHICHEVER SHALL OCCUR FIRST. EXCEPT AS OTHERWISE REQUIRED BY LAW, BUYER'S EXCLUSIVE REMEDY AND SELLER'S AGGREGATE LIABILITY FOR BREACH OF ANY OF THE FOREGOING WARRANTIES ARE LIMITED TO REPAIRING OR REPLACING THE PRODUCT AND SHALL IN ALL CASES BE LIMITED TO THE AMOUNT PAID BY THE BUYER FOR THE DEFECTIVE PRODUCT. IN NO EVENT SHALL SELLER BE LIABLE FOR ANY OTHER FORM OF DAMAGES, WHETHER DIRECT, INDIRECT, LIQUIDATED, INCIDENTAL, CONSEQUENTIAL, PUNITIVE, EXEMPLARY OR SPECIAL DAMAGES, INCLUDING BUT NOT LIMITED TO LOSS OF PROFIT, LOSS OF ANTICIPATED SAVINGS OR REVENUE, LOSS OF INCOME, LOSS OF BUSINESS, LOSS OF PRODUCTION, LOSS OF OPPORTUNITY OR LOSS OF REPUTATION.**

Some states do not allow limitations on how long an implied warranty lasts, so the above limitation may not apply to you. Some states do not allow the exclusion or limitation of incidental or consequential damages, so the above exclusions may not apply to you. This warranty gives you specific legal rights, and you may also have other rights which may vary from state to state.

To make a warranty claim, check first with the dealer from whom you purchased the product or call +1-847-966-3700 for the name and location of the nearest dealer providing warranty service.

**xylem**  
Let's Solve Water

Xylem Inc.  
8200 N. Austin Avenue  
Morton Grove, Illinois 60053  
Phone: (847) 966-3700  
Fax: (847) 965-8379  
[www.xylem.com/mcdonnellmiller](http://www.xylem.com/mcdonnellmiller)

McDonnell & Miller is a trademark of Xylem Inc. or one of its subsidiaries.  
© 2019 Xylem Inc. MM-323H March 2019 Part No. 211163

