

FPC-1000 Field Configurable Low Water Cut-off

for Steam and Hot Water Boilers

<https://qr.xylemsales.com/mm-211320>



1 Introduction and Safety

1.1 Introduction

Purpose of this manual

The purpose of this manual is to provide necessary information for:

- Installation
- Operation
- Maintenance



CAUTION:

Read this manual carefully before installing and using the product. Improper use of the product can cause personal injury and damage to property, and may void the warranty.

NOTICE:

Save this manual for future reference, and keep it readily available at the location of the unit.



1.2 Safety terminology and symbols

About safety messages

It is extremely important that you read, understand, and follow the safety messages and regulations carefully before handling the product. They are published to help prevent these hazards:



- Personal accidents and health problems
- Damage to the product and its surroundings
- Product malfunction

Hazard levels

Hazard level	Indication
 DANGER:	A hazardous situation which, if not avoided, will result in death or serious injury
 WARNING:	A hazardous situation which, if not avoided, could result in death or serious injury
 CAUTION:	A hazardous situation which, if not avoided, could result in minor or moderate injury
NOTICE:	Notices are used when there is a risk of equipment damage or decreased performance, but not personal injury.

Special symbols

Some hazard categories have specific symbols, as shown in the following table.

Electrical hazard	Magnetic fields hazard
 Electrical Hazard:	 CAUTION:

1.3 Safety



WARNING:

- The operator must be aware of safety precautions to prevent physical injury.
- Operating, installing, or maintaining the unit in any way that is not covered in this manual could cause death, serious personal injury, or damage to the equipment. This includes any modification to the equipment or use of parts not provided by Xylem. If there is a question regarding the intended use of the equipment, please contact a Xylem representative before proceeding.
- Do not change the service application without the approval of an authorized Xylem representative.



CAUTION:

You must observe the instructions contained in this manual. Failure to do so could result in physical injury, damage, or death.



WARNING:

We recommend that secondary (redundant) Low Water Cut-Off controls be installed on all steam boilers with heat input greater than 400,000 BTU/hour or operating above 15 psi of steam pressure. At least two controls should be connected in series with the burner control circuit to provide safety redundancy protection should the boiler experience a low water condition. Moreover, at each annual outage, the low water cutoffs should be dismantled, inspected, cleaned, and checked for proper calibration and performance.

1.4 User safety

General safety rules

These safety rules apply:

- Always keep the work area clean.
- Pay attention to the risks presented by gas and vapors in the work area.
- Avoid all electrical dangers. Pay attention to the risks of electric shock or arc flash hazards.
- Always bear in mind the risk of drowning, electrical accidents, and burn injuries.

Safety equipment

Use safety equipment according to the company regulations. Use this safety equipment within the work area:

- Hard hat
- Safety goggles, preferably with side shields
- Protective shoes
- Protective gloves
- Gas mask
- Hearing protection
- First-aid kit
- Safety devices

2 Product Description

2.1 General description

Description

The FPC-1000 is a probe type LWCO, that can be configured for operation for either STEAM or HOT WATER boilers by the customer at the installation site. The control is dual input voltage compatible and ready for operating with either 24VAC or 120VAC power supply. During operation, a Red LED light alerts personnel to a low water condition and a Green/Yellow (Auto/Manual) LED light to indicate control mode. At power up, all LEDs will be blinking 4 times to indicate Hot-Water boiler type or blinking 6 times to indicate Steam boiler type.



WARNING:

This product can expose you to chemicals including Lead, which is known to the State of California to cause cancer and birth defects or other reproductive harm. For more information go to: www.P65Warnings.ca.gov.

Lockout delay

For manual reset units, when a low water condition occurs, the burner turns off and the Red LED begins to blink. When the water level is not restored to a level above the probe within 30 seconds, the control locks out. To reset control, press the Test/Reset button when the water level is restored to a level above the probe.

Power interruption Auto Mode

The control will automatically reset after a loss of power as long as there is water on the probe before and after the power loss occurred.

CSD-1 code compliance

For manual reset units, when the control is in a low water condition and there is an interruption of power the control remains in that condition when power is restored. To re-establish function to the LWCO, press the Test/Reset button when the water level is restored to a level above the probe.



CAUTION:

Flood hazard. Do not use manual reset models with automatic water feeders.

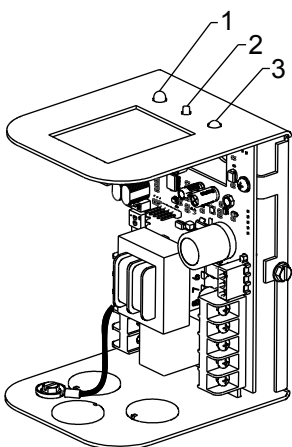

1. Power on LED, Green (Auto)/Yellow (Manual)
2. Test/Reset/Configuration button
3. Low water LED, Red

Figure 1: Control unit

2.2 Operational specifications

Control unit ratings

Storage temperature	-40°F to 120°F (-40°C to 49°C)
Ambient temperature	32°F to 120°F (0°C to 49°C)
Humidity	85% non-condensing

Operation Specifications

Boiler type	Hot Water		Steam	
	Manual	Auto	Manual	Auto
Control mode	Manual	Auto	Manual	Auto
Product configuration mode	Manual-Hot Water	Auto-Hot Water	Manual-Steam	Auto-Steam
Probe sensitivity	~20 K Ohm	~20 K Ohm	~7.5 K Ohm	~7.5 K Ohm
DOM	~3 sec	~3 sec	~3 sec	~30 sec (see Note)
DOB	~5 sec	~5 sec	~5 sec	~5 sec
Foam detection	NA	NA	NA	YES

Note: For Bluetooth model, DOM (15/30/45/60 seconds) time for Steam-Auto mode can be configured through the optimize application.

Probe specifications

Maximum water pressure: 160 psi (11.2 kg/cm²)
 Maximum steam pressure: 15 psi (1.0 kg/cm²)

Probe dimensions in inches (mm)

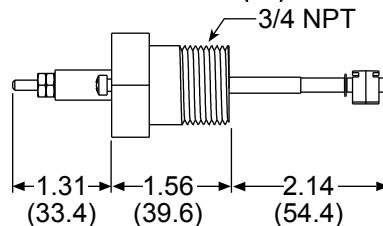

Figure 2: PA-800 Standard probe (354081)

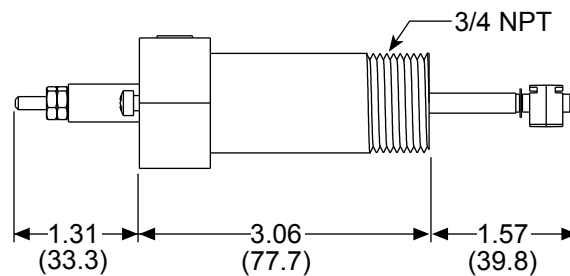

Figure 3: PA-800-U "U" probe (354141)

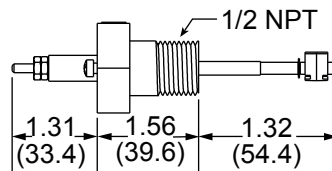

Figure 4: PA-800-RX2 "RX2" probe (354140)

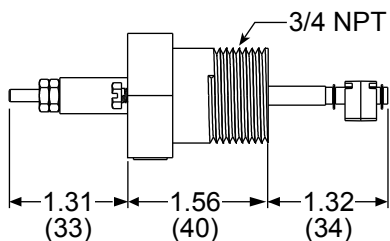

Figure 5: PA-RB-122 Short probe (354083)

2.3 Electrical specifications

Table 1: Electrical ratings

Model	Control voltage	Motor switch rating		Pilot duty
		Full load	Locked rotor	
FPC-1000	24 VAC	N/A	N/A	50 VA
FPC-1000-P	120 VAC	7.5 FLA	43.2 LRA	125 VA at 120 VAC, 50 Hz or 60 Hz
FPC-1000-U				
FPC-1000-RX2				
FPC-1000-SP				
FPCe-1000				

Hz	Control power consumption	Electrical enclosure rating
50/60	3 VA maximum	NEMA 1 general purpose

2.4 Device configuration

NOTE: Device must be connected to input voltage in order to power up. See Chapter 3, Installation.

- Turn on the FPC-1000.
- The device must be in Default mode indicated by the Green, Yellow and Red LEDs blinking alternately for configuring a required operation mode and boiler type.
- Set the SW3 DIP switch which is an SPST DIP switch for Hot Water/Steam selection. Slide the switch to the desired position (Water/Steam) per the labels marked on the PCB. See the picture below of the SW3 switch to configure device in Hot-Water mode.

STEAM



WATER

- Set the SW4 DIP switch which is a dual DPDT DIP switch for Auto and Manual selection. Slide the switch to the ON position for selection of desired boiler type control mode (Auto/Manual) and other switch to OFF position per the labels marked on the PCB. See the picture below of the SW4 to configure device in Auto control mode.



- After setting SW3 and SW4 DIP switches, Green or Yellow LED will blink as per Auto or Manual control selection respectively. If switch position of any DIP switches is not set appropriately, both Green and Yellow LEDs will blink alternately (1s rate).
- After configuring the DIP switches, press and hold the Test/Reset button for 30 seconds. LED will blink for 20 seconds, then will blink faster for 10 seconds.
- Once the Red LED and Green/Yellow (Auto/Manual) LEDs are solid on, release the Test/Reset button.

- The device will reset and restart after releasing the Test/Reset button.
- On device reset or power on, the LEDs will blink as in the following table for each device configuration mode:

Table 2: Configuration and operation control

Boiler Type	Hot Water		Steam	
	Manual	Auto	Manual	Auto
Control Mode	Manual	Auto	Manual	Auto
Status LED (Power-On Condition)	Yellow LED (4 times blinking)	Green LED (4 times blinking)	Yellow LED (6 times blinking)	Green LED (6 times blinking)
LWCO Condition	Red LED	Red LED	Red LED	Red LED

NOTE: The above configuration is only for one time setup and cannot be re-configured to different boiler type and/or control mode after the first setup.

NOTE: Product configuration can be indicated by the status LEDs and should be inspected by an operator:

- GREEN/YELLOW (AUTO/MANUAL) LED blinks 4 times during power-on condition for HOT-WATER boiler application.
- GREEN/YELLOW (AUTO/MANUAL) LED blinks 6 times during power-on condition for STEAM boiler application.

After the product is configured, the product label should be updated/marked up by the operator.

NOTE: If the control is in low water condition when the power to the unit is interrupted in manual control mode, the operator must press the Test/Reset button to reset the unit when the power is restored and the water level is again above the level of the probe.

3 Installation

3.1 Determine location for the probe installation



DANGER:

Electrical hazard sufficient to kill. Always disconnect and lock out the power before you service the unit.



CAUTION:

- Low water cut-off must be installed in series with all other limit and operating controls on the boiler. Check for proper operation of all of the limit and operating controls before leaving the site.
- All work must be performed by qualified personnel trained in the proper application, installation, and maintenance of plumbing, steam and electrical equipment or systems in accordance with all applicable codes and regulations.

3.2 Where to install

Based on the following criteria locate a suitable position for the probe (A):

For all Applications:

- Make sure probe is installed above minimum safe water line as determined by the boiler manufacturer.
- Make sure that ends and sides of the probe are at least 1/4" (6.4 mm) from all internal metal surfaces. See "A" in Figure 7 on page 4
- Make sure the probe is positioned to shut off the boiler before the water level falls below the lowest visible part of the gauge glass.

For Steam Boilers:

- Refer to boiler manufacturer's instructions to determine suitable tapping for the probe.

For Hot Water Boilers:

- Refer to boiler manufacturer's instructions to determine suitable tapping for the probe.
- Locate probe in supply piping using a tee fitting.

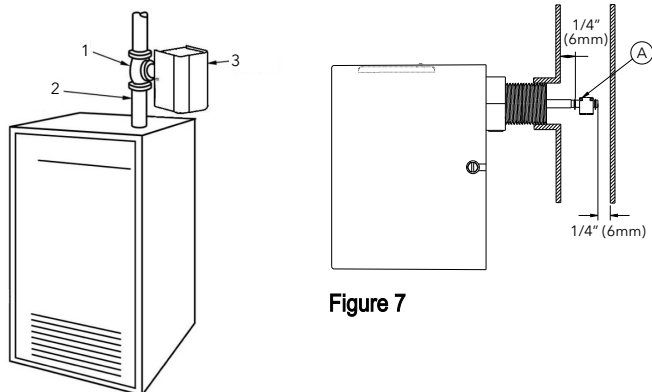

1. Tee Fitting
2. Riser Pipe
3. Probe Control

Figure 6: Hot water boilers

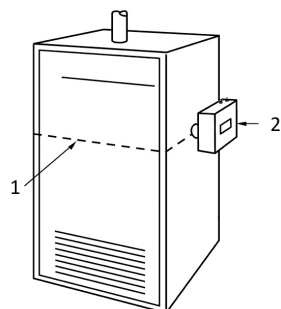

1. Minimum Safe Water Level (May vary by boiler manufacturer)
2. Probe Control

Figure 8: Hot water or steam boilers

3.3 Install the probe

1. Apply a small amount of pipe sealant to the external threads (2) of the probe (1).



WARNING:

Do not use PTFE tape or paste. Only use pipe sealant. Failure to follow these instructions will cause the probe not to function as intended and could cause property damage, personal injury or death.

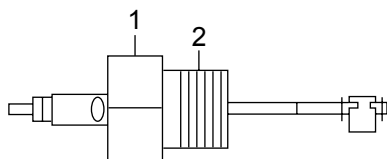

2. Tighten the probe (1) into the tapped connection (3).

Be sure to align the probe so that the mounting screws (4) are in a horizontal position.

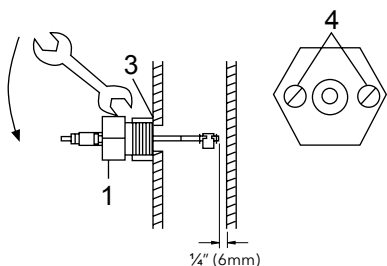

3.4 Install the control housing

1. Loosen the screws that secure the cover (5) to the control housing about 1-1/2 turns. Remove cover.

Figure 7

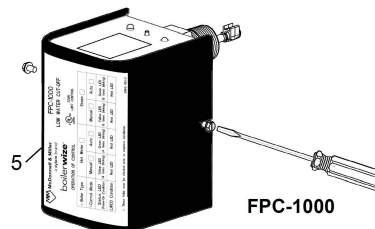

2. Loosen the probe mounting screws.
3. Slip the control housing (6) over the two screws at a 20° angle.
4. Rotate the control housing (6) 20° counter-clockwise so that the slots in the control base are under the screws heads.
5. Tighten the mounting screws.

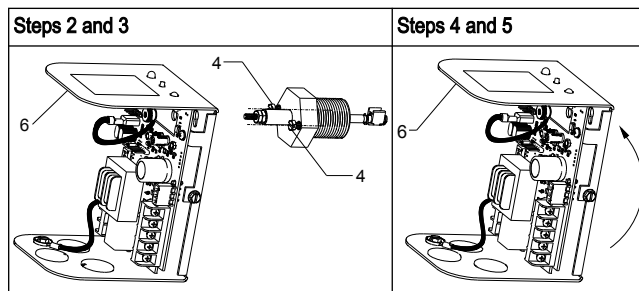

3.5 Wire the probe to the control housing

1. Slip the ring terminal (7) followed by the lock washer (8) over the threaded end of the probe (1).
2. Tighten the wingnut (9) onto the probe (5 inch-lbs minimum).

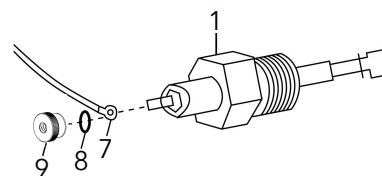

3. Connect the probe (1) to the wiring circuit by sliding the female quick-connect terminal of the probe wire (10) onto the male spade terminal (11). The male spade terminal is marked PROBE.

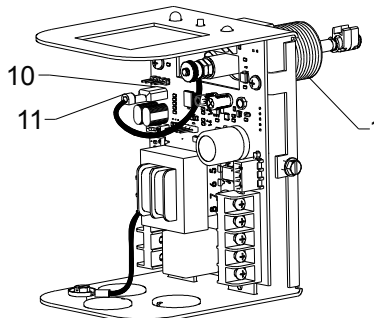

3.6 Electrical conduit connections



WARNING:

- Fire hazard. Electrical wiring must have a rating of 167°F (75°C) if the liquid exceeds 180°F (82°C).
- When installing factory jumper bar make sure you are not introducing a second voltage source into the burner circuit and thereby bypassing other safety, limit, and operating controls.

- Connect electric conduit using knockouts provided.
- Follow accepted electrical practices for installation of fittings and connections.
- Refer to and follow local codes and standards when selecting the types of electrical fittings and conduit.

3.7 Wire connections to the terminal block



CAUTION: Electrical connections

Electrical connections must be made by certified electricians in compliance with all international, national, state, and local regulations. For more information about requirements, see sections dealing specifically with electrical connections.

Use the following instructions for all wire connections to the terminal block.

1. Strip about 1/3" (8.5 mm) of insulation from the wire.
2. Loosen the terminal screw (2) but do not remove it.
3. Move the wire clamping plate (3) back until the plate touches the back side of the screw head.
4. Insert the stripped end of the wire between the terminal block (1) and the wire clamping plate (3).
5. Tighten the terminal screw (2).

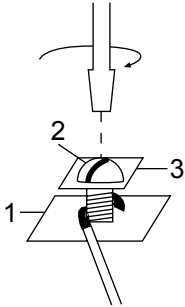

3.8 Remote sensor wiring

1. Connect ground wire from remote sensor green ground screw to GROUND terminal on FPC-1000 PCB.
2. Connect probe wire from probe end to PROBE terminal on FPC-1000 PCB.

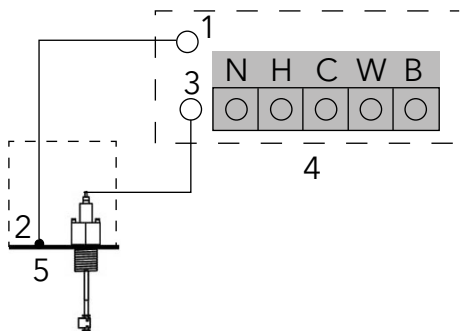

1. GROUND terminal on PCB
2. Chassis ground screw
3. PROBE terminal on PCB
4. FPC-1000
5. Remote sensor

Wiring Diagram Legend

- Solid black lines indicate action to be taken in step shown.
- Dotted black lines indicate internal wiring.

NOTE: Probe wires should be minimum 18 AWG stranded with glass braided Silicone jacket (UL 3071) suitable for high temperature 392°F (200°C) service.

3.9 Control wiring



WARNING:

Electrical connections are to be made by a qualified electrician in accordance with all applicable codes, ordinance and good practices.



WARNING:

The probe wire must be connected to the terminal connection marked with "PROBE" from PCB and ground wire must be connected to the terminal connection marked with "GND" from PCB.



CAUTION:

Failure to follow warning could cause property damage, personal injury or death

Table 3: Power supply schemes

Terminal designation and abbreviation	Terminal of TB2	Terminal of TB1
Hot	H	24 VAC - H
Neutral	N	24 VAC - N
Common	C	C
Water	W	W
Burner	B	B

EN

NOTE: Never supply two different voltages to TB1 and TB2 at the same time. Only one supplied voltage, either 120 VAC or 24 VAC to be applied to TB1 or TB2, respectively.

NOTE: A loose factory jumper bar is included in the product box.

NOTE: For 120 VAC, Connect terminal H and terminal C using jumper bar for TB1 OR For 24 VAC, Connect terminal H and terminal C using jumper bar for TB2.

WARNING: Never connect terminal H and terminal C of both TB1 & TB2 at the same time using the jumper bar to avoid damaging the control.

3.9.1 Control Wiring Schemes: Same voltage for control and burner circuit

- Connect hot wire to terminal H.
- Connect neutral wire to terminal N.
- Connect factory jumper bar from terminal H to terminal C.
- Connect a wire from terminal B to the next safety device of the Burner's safety circuit, such as thermostat, gas valve, limits, etc.
- Connect wire from end of Burner circuit to terminal N.

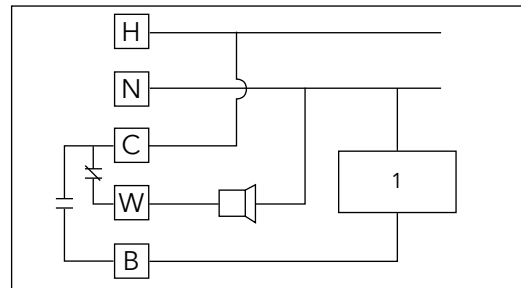

1. BURNER LIMIT CONTROL

3.9.2 Control Wiring Schemes: Different voltage for control and Burner circuit

- Connect hot wire to terminal H.
- Connect neutral wire to terminal N.
- Connect hot wire from the separate power supply to terminal C.
- Connect a wire from terminal B to the next safety device in the circuit.
- Connect black wire from probe end to terminal.

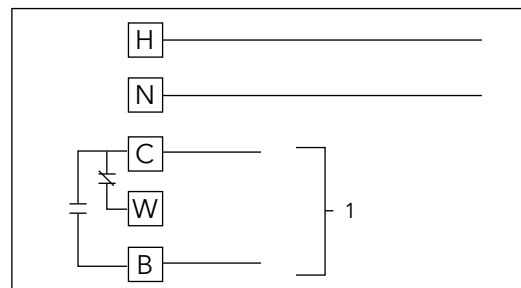

1. Wired in series as a part of burner control

3.9.3 Control wiring: FPC-1000 can be used as primary and secondary with the same supply voltage

Series 750 as primary and FPC-1000 as secondary

- Remove existing wire from terminal 5 of existing Auto Reset LWCO and connect to terminal B of new Manual Reset LWCO.
- Connect new wire from terminal 5 of existing Auto Reset LWCO to terminal H of new Manual Reset LWCO.
- Connect new wire from terminal 2 of existing Auto Reset LWCO to terminal N of new Manual Reset LWCO.

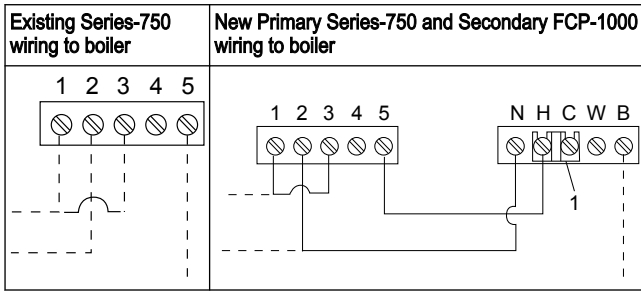

NOTE: Terminal 3 and 4 and Terminal N and H must be at the same voltage. Either 24 VAC supplied for TB2 or 120 VAC supplied for TB1 of the FPC-1000.

NOTE: Only an electronic water feeder can be used with the FPC-1000 controller for correct functioning.

4 Testing

4.1 Start-Up

Refer the preceding Operation of Control table

- Before filling the system**, turn on the electric power to the boiler.
 - Upon initial power up, the Green/Yellow (Auto/Manual) and Red lights will flash simultaneously 4 times (Hot Water) or 6 times (Steam).
 - The Green/Yellow (Auto/Manual) light will turn "ON".
 - Red LED will be flashing for 5 sec. in Auto mode or 30 sec. in Manual mode and turn solid on afterward.
 - The burner will never turn "ON" during power up, if water is off the probe.
- Now fill the boiler with water.**

(For manual reset units, when water returns to the probe, nothing will happen until the manual Test/Reset button is depressed.)

- The Green/Yellow (Auto/Manual) and Red lights will flash simultaneously 4 times (Hot Water) or 6 times (Steam) if the controller power was recycled.
 - Then the Green/Yellow (Auto/Manual) light will turn "ON" and the Red light will be blinking for 30 sec. in Auto Steam mode or blinking for 3 sec. in all other modes and turn off after that.
 - The burner will be "ON" as long as there is water on the probe
- Slowly drain the boiler of water.**
 - When the water drops off the probe, the Green/Yellow (Auto/Manual) light remains "ON".
 - The Red light starts flashing and the burner will turn "OFF", if water is off the probe.
Red LED will turn "OFF" and burner turns "ON" if water returns to probe during 30 sec. lock-out period in Manual mode or whenever water returns to probe after DOM time in Auto mode.

- Testing Control Using "ON" and "Test/Reset Button". Depressing the Test/Reset button with "water on probe":**

(Must depress and hold Test/Reset button for 5 sec. to simulate out of water condition. On Manual Reset Units, depress and hold Test/Reset button for 30 sec. for testing lock-out/CSD-1 condition). Red LED will flash and Green/Yellow (Auto/Manual) is "ON".)

- Both Red and Green/Yellow (Auto/Manual) LEDs stay "ON" after reset cycle is activated.
- The burner will turn "OFF".
(Release Test/Reset button. You must depress the manual Test/Reset button to unlock the low water cut-off for Manual mode.)
- Then the Green/Yellow (Auto/Manual) light will turn "ON" and the Red light will blink for DOM times and after that turn "OFF".
- The burner will turn "ON" as long as there is water on the probe. The LEDs will be blinking 4 times (Hot Water) or 6 times (Steam) for Manual mode only when the controller is reset to take out from lock-out condition.

CSD-1 code compliance

For manual reset units, when the control is in a low water condition and there is an interruption of power the control remains in that condition when power is restored. To re-establish function to the LWCO, press the Test/Reset button when the water level is restored to a level above the probe.

5 Maintenance

5.1 Maintenance schedule



WARNING:

- Maintenance and service must be performed by skilled and qualified personnel only.
- Replace probe when PFA insulator is cracked or worn or probe is loose.

- Test the low water cut-off annually or more frequently, by pressing the test button.
- Remove and inspect the self-cleaning probe every five years.
 - Use a non-abrasive cloth and rinse with clean water when the probe requires cleaning. Do not use sharp instruments to remove accumulations of rust or scale.
- Replace probe every ten years.
- Replace the low water cut-off control box every 15 years.

3.9.4 Series PSE-800 as primary and FPC-1000 as secondary

- Remove existing wire from terminal B of existing Auto Reset LWCO and connect to terminal B of new Manual Reset LWCO.
- Connect new wire from terminal B of existing Auto Reset LWCO to terminal H of new Manual Reset LWCO.
- Connect new wire from terminal N of existing Auto Reset LWCO to terminal N of new Manual Reset LWCO.

NOTE: Terminals 1 and 2 and Terminals N and H must be at the same voltage. Either 24 VAC supplied for TB2 or 120 VAC supplied for TB1 of the FPC-1000.

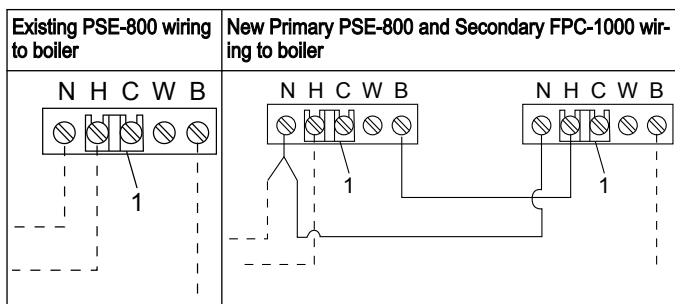

- Factory jumper bar

----- Dashed lines indicate existing wires.

_____ Solid lines indicate new wires.

NOTE: All N and H terminals must be at the same voltage. Either 24 VAC supplied for TB2 or 120 VAC supplied for TB1 of the FPC-1000.

3.9.5 Control wiring with secondary: Wiring a new manual reset LWCO to a boiler with a Model 67 LWCO. Voltage of the new manual reset LWCO must be the same voltage as the burner circuit

- Remove existing wire from terminal 1 of the Model 67 LWCO and connect it to Terminal B of the new manual reset LWCO.
- Connect a new wire from terminal 1 of Model 67 LWCO to terminal H of the new manual reset LWCO.
- Connect a new wire to terminal N of new manual reset LWCO and splice it to the existing neutral wire.

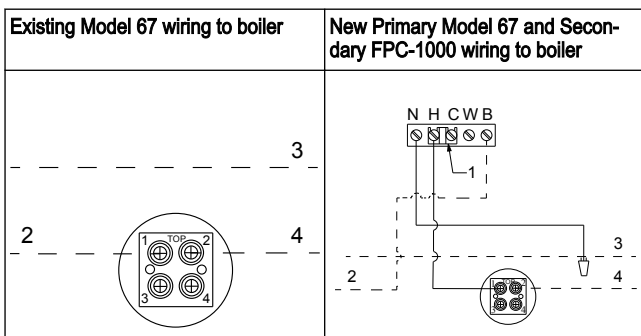

- Factory jumper bar
- To burner
- Neutral
- Hot

----- Dashed lines indicate existing wires.

_____ Solid lines indicate new wires.

6 Troubleshooting

6.1 Probe fails to operate

Perform the following diagnostic checks if the probe fails to operate as required:

1. Check that the water level in the boiler is at or above the level of the probe.
2. Recheck all wiring to ensure proper connections as specified in the wiring diagrams of the boiler manufacturer or in this instruction manual.
3. Check to ensure that PTFE tape has not been used on the threaded connection of the electrode to the boiler.
4. Some foaming is common in certain boilers. Refer to recommendations from the boiler manufacturer for cleaning the boiler and piping when excessive foaming occurs.

5. Boiler does not turn ON and FPC-1000 Green/Yellow (Auto/Manual) LED continues blinking 13 times: The probe is shorting at power on.
 - Turn off boiler and check probe wiring connection.
 - Turn off boiler, drain boiler and remove control to check if the tip of the probe is touching a metal surface.
6. Boiler does not turn ON and FPC-1000 Green/Yellow (Auto/Manual) LED continues blinking from 1 to 10 times: Internal faults.
 - Press the Test/Reset button for more than 1 second until the Red LED turns off or perform a power cycle to reset the device.
 - If the problem continues, replace the control with a new unit.

7 Product Warranty

7.1 Commercial warranty

Warranty. For goods sold to commercial buyers, Seller warrants the goods sold to Buyer hereunder (with the exception of membranes, seals, gaskets, elastomer materials, coatings and other “wear parts” or consumables all of which are not warranted except as otherwise provided in the quotation or sales form) will be (i) be built in accordance with the specifications referred to in the quotation or sales form, if such specifications are expressly made a part of this Agreement, and (ii) free from defects in material and workmanship for a period of one (1) year from the date of installation or two (2) years from the date of manufacture, whichever shall occur first, unless a longer period is specified in the product documentation (the “Warranty”).

Except as otherwise required by law, Seller shall, at its option and at no cost to Buyer, either repair or replace any product which fails to conform with the Warranty provided Buyer gives written notice to Seller of any defects in material or workmanship within ten (10) days of the date when any defects or non-conformance are first manifest. Under either repair or replacement option, Seller shall not be obligated to remove or pay for the removal of the defective product or install or pay for the installation of the replaced or repaired product and Buyer shall be responsible for all other costs, including, but not limited to, service costs, shipping fees and expenses. Seller shall have sole discretion as to the method or means of repair or replacement. Buyer’s failure to comply with Seller’s repair or replacement directions shall terminate Seller’s obligations under this Warranty and render the Warranty void. Any parts repaired or replaced under the Warranty are warranted only for the balance of the warranty period on the parts that were repaired or replaced. Seller shall have no warranty obligations to Buyer with respect to any product or parts of a product that have been: (a) repaired by third parties other than Seller or without Seller’s written approval; (b) subject to misuse, misapplication, neglect, alteration, accident, or physical damage; (c) used in a manner contrary to Seller’s instructions for installation, operation and maintenance; (d) damaged from ordinary wear and tear, corrosion, or chemical attack; (e) damaged due to abnormal conditions, vibration, failure to properly prime, or operation without flow; (f) damaged due to a defective power supply or improper electrical protection; or (g) damaged resulting from the use of accessory equipment not sold or approved by Seller. In any case of products not manufactured by Seller, there is no warranty from Seller; however, Seller will extend to Buyer any warranty received from Seller’s supplier of such products.

THE FOREGOING WARRANTY IS EXCLUSIVE AND IN LIEU OF ANY AND ALL OTHER EXPRESS OR IMPLIED WARRANTIES, GUARANTEES, CONDITIONS OR TERMS OF WHATEVER NATURE RELATING TO THE GOODS PROVIDED HEREUNDER, INCLUDING WITHOUT LIMITATION ANY IMPLIED WARRANTIES OF MERCHANTABILITY AND FITNESS FOR A PARTICULAR PURPOSE, WHICH ARE HEREBY EXPRESSLY DISCLAIMED AND EXCLUDED. EXCEPT AS OTHERWISE REQUIRED BY LAW, BUYER’S EXCLUSIVE REMEDY AND SELLER’S AGGREGATE LIABILITY FOR BREACH OF ANY OF THE FOREGOING WARRANTIES ARE LIMITED TO REPAIRING OR REPLACING THE PRODUCT AND SHALL IN ALL CASES BE LIMITED TO THE AMOUNT PAID BY THE BUYER FOR THE DEFECTIVE PRODUCT. IN NO EVENT SHALL SELLER BE LIABLE FOR ANY OTHER FORM OF DAMAGES, WHETHER DIRECT, INDIRECT, LIQUIDATED, INCIDENTAL, CONSEQUENTIAL, PUNITIVE, EXEMPLARY OR SPECIAL DAMAGES, INCLUDING BUT NOT LIMITED TO LOSS OF PROFIT, LOSS OF ANTICIPATED SAVINGS OR REVENUE, LOSS OF INCOME, LOSS OF BUSINESS, LOSS OF PRODUCTION, LOSS OF OPPORTUNITY OR LOSS OF REPUTATION.

7.2 Limited consumer warranty

Warranty. For goods sold for personal, family or household purposes, Seller warrants the goods purchased hereunder (with the exception of membranes, seals, gaskets, elastomer materials, coatings and other “wear parts” or consumables all of which are not warranted except as otherwise provided in the quotation or sales form) will be free from defects in material and workmanship for a period of one (1) year from the date of installation or two (2) years from the product date code, whichever shall occur first, unless a longer period is provided by law or is specified in the product documentation (the “Warranty”).

Except as otherwise required by law, Seller shall, at its option and at no cost to Buyer, either repair or replace any product which fails to conform with the Warranty provided Buyer gives written notice to Seller of any defects in material or workmanship within ten (10) days of the date when any defects or non-conformance are first manifest. Under either repair or replacement option, Seller shall not be obligated to remove or pay for the removal of the defective product or install or pay for the installation of the replaced or repaired product and Buyer shall be responsible for all other costs, including, but not limited to, service costs, shipping fees and expenses. Seller shall have sole discretion as to the method or means of repair or replacement. Buyer’s failure to comply with Seller’s repair or replacement directions shall terminate Seller’s obligations under this Warranty and render this Warranty void. Any parts repaired or replaced under the Warranty are warranted only for the balance of the warranty period on the parts that were repaired or replaced.

Seller shall have no warranty obligations to Buyer with respect to any product or parts of a product that have been: (a) repaired by third parties other than Seller or without Seller’s written approval; (b) subject to misuse, misapplication, neglect, alteration, accident, or physical damage; (c) used in a manner contrary to Seller’s instructions for installation, operation and maintenance; (d) damaged from ordinary wear and tear, corrosion, or chemical attack; (e) damaged due to abnormal conditions, vibration, failure to properly prime, or operation without flow; (f) damaged due to a defective power supply or improper electrical protection; or (g) damaged resulting from the use of accessory equipment not sold or approved by Seller. In any case of products not manufactured by Seller, there is no warranty from Seller; however, Seller will extend to Buyer any warranty received from Seller’s supplier of such products.

THE FOREGOING WARRANTY IS PROVIDED IN PLACE OF ALL OTHER EXPRESS WARRANTIES. ALL IMPLIED WARRANTIES, INCLUDING BUT NOT LIMITED TO THE IMPLIED WARRANTIES OF MERCHANTABILITY AND FITNESS FOR A PARTICULAR PURPOSE, ARE LIMITED TO ONE(1) YEAR FROM THE DATE OF INSTALLATION OR TWO (2) YEARS FROM THE PRODUCT DATE CODE, WHICHEVER SHALL OCCUR FIRST. EXCEPT AS OTHERWISE REQUIRED BY LAW, BUYER’S EXCLUSIVE REMEDY AND SELLER’S AGGREGATE LIABILITY FOR BREACH OF ANY OF THE FOREGOING WARRANTIES ARE LIMITED TO REPAIRING OR REPLACING THE PRODUCT AND SHALL IN ALL CASES BE LIMITED TO THE AMOUNT PAID BY THE BUYER FOR THE DEFECTIVE PRODUCT. IN NO EVENT SHALL SELLER BE LIABLE FOR ANY OTHER FORM OF DAMAGES, WHETHER DIRECT, INDIRECT, LIQUIDATED, INCIDENTAL, CONSEQUENTIAL, PUNITIVE, EXEMPLARY OR SPECIAL DAMAGES, INCLUDING BUT NOT LIMITED TO LOSS OF PROFIT, LOSS OF ANTICIPATED SAVINGS OR REVENUE, LOSS OF INCOME, LOSS OF BUSINESS, LOSS OF PRODUCTION, LOSS OF OPPORTUNITY OR LOSS OF REPUTATION.

Some states do not allow limitations on how long an implied warranty lasts, so the above limitation may not apply to you. Some states do not allow the exclusion or limitation of incidental or consequential damages, so the above exclusions may not apply to you. This warranty gives you specific legal rights, and you may also have other rights which may vary from state to state.

To make a warranty claim, check first with the dealer from whom you purchased the product or call +1-847-966-3700 for the name and location of the nearest dealer providing warranty service.

Xylem Inc
8200 N. Austin Avenue
Morton Grove, Illinois 60053
USA

Tel: (847) 966-3700
Fax: (847) 965-8379

www.xylem.com/mcdonnellmiller

McDonnell & Miller is a trademark of Xylem Inc. or one of its subsidiaries. All other trademarks or registered trademarks are property of their respective owners.

© 2024 Xylem Inc.

xylem
Let's Solve Water