



Cascading the
FT SERIES

Wall-Mounted, Modulating
Gas, Condensing,
Heating Only, Boiler

Model MFTHW
80,000 BTU/hr
100,000 BTU/hr
120,000 BTU/hr
140,000 BTU/hr
199,000 BTU/hr

- Natural Gas (NG)
Factory Configuration
- Propane Gas (LP)
Field-Convertible

FOR YOUR SAFETY: This product must be installed and serviced by a professional service technician, qualified in hot water boiler and heater installation and maintenance. Improper installation and/or operation could create carbon monoxide gas in flue gases which could cause serious injury, property damage, or death. Improper installation and/or operation will void the warranty.

⚠ WARNING

If the information in this manual is not followed exactly, a fire or explosion may result causing property damage, personal injury or loss of life.

Do not store or use gasoline or other flammable vapors and liquids in the vicinity of this or any other appliance.

WHAT TO DO IF YOU SMELL GAS

- Do not try to light any appliance.
- Do not touch any electrical switch; do not use any phone in your building.
- Immediately call your gas supplier from a nearby phone. Follow the gas supplier's instructions.
- If you cannot reach your gas supplier, call the fire department.

Installation and service must be performed by a qualified installer, service agency, or gas supplier.

⚠ AVERTISSEMENT

Assurez-vous de bien suivre les instructions données dans cette notice pour réduire au minimum le risque d'incendie ou d'explosion ou pour éviter tout dommage matériel, toute blessure ou la mort.

Ne pas entreposer ni utiliser d'essence ou ni d'autres vapeurs ou liquides inflammables dans le à proximité de cet appareil ou de tout autre appareil.

QUE FAIRE SI VOUS SENTEZ UNE ODEUR DE GAZ:

- Ne pas tenter d'allumer d'appareils.
- Ne touchez à aucun interrupteur. Ne pas vous servir des téléphones dans le bâtiment où vous vous trouvez.
- Appelez immédiatement votre fournisseur de gaz depuis un voisin. Suivez les instructions du fournisseur.
- Si vous ne pouvez rejoindre le fournisseur de gaz, appelez le service des incendies.

L'installation et l'entretien doivent être assurés par un installateur ou un service d'entretien qualifié ou par le fournisseur de gaz.

Table of Contents

SECTION 1

Piping

- A. General Plumbing Connection Guidelines ... 3
- B. Install a Backflow Preventer..... 3
- C. Piping Diagrams for Cascading Systems.. 3-7

SECTION 2

Electrical

- A. Wiring Connections for Cascade..... 8
- B. Terminal Blocks..... 9

SECTION 3

The Control Display

- A. The Control Display..... 10
- B. The LCD..... 10
- C. Start-Up Sequence..... 11

SECTION 4

Cascade Programming

- A. Programming a Cascade System 12
- B. The Cascade CH Function..... 13-14
- C. Domestic Hot Water 'Storage Mode'
for Cascade System..... 14
- D. Cascade System Error Codes..... 15

SECTION 1 Piping

Multiple FT Series boilers can be connected via a cascade communication cable to create a bank of boilers that work in tandem. Up to 20 boilers can be controlled by a “Leader” FT Series boiler with the others acting as “Followers”.

⚠ WARNING

Do not use FT Series units on common vents. Each unit must have its own supply and exhaust vents.

A. General Plumbing Connection Guidelines

- Pipe material must be suitable to meet local codes and industry standards.
- The pipe must be cleaned and without blemish before any connections are made.
- Do not apply a torch within 12” of the bottom connections of the Heating Only Boiler. Doing so could damage the Heating Only Boiler. Such damages ARE NOT covered by product warranty.
- The size of the CH supply pipe should be 1¼” diameter.
- Isolation (shutoff valves) should be used to ease future servicing.
- All piping should be insulated.

B. Install a Backflow Preventer

It may be recommended to use a back flow preventer – check local codes. If a back flow preventer or a no return valve is used, a thermal expansion tank must be installed on the cold water supply between the Heating Only Boiler and valve.

⚠ WARNING

To control thermal expansion, a thermal expansion tank should be installed in systems with an installed backflow preventer. DO NOT use a closed type expansion tank. Follow expansion tank manufacturer’s specifications to properly size an expansion tank to the installation. Failure to properly accommodate thermal expansion could result in property damage, severe personal injury, or death.

C. Piping Diagrams for Cascading Systems

The next four pages give examples of typical cascading hydronic piping diagrams.

⚠ CAUTION

Use at least the MINIMUM pipe size for all Heating Only Boiler loop piping. This is to avoid the possibility of inadequate flow through the Heating Only Boiler. Using less than the required minimum pipe size and piping could result in system problems, property damage, and premature Heating Only Boiler failure. Such problems ARE NOT covered by product warranty.

Use both thread tape and pipe dope to connect to the 1¼” CH supply and return. Isolation valves between the city water supply and inlet are recommended for ease of service.

Cascade Manifold Pipe Sizing (inches)

SIZE	Number of cascaded FT units						
	2	3	4	5	6	7	8
80	1 1/4	1 1/2	2	2	2	2 1/2	3
100	1 1/2	2	2	2 1/2	2 1/2	3	3
120	1 1/2	2	2 1/2	2 1/2	3	3	3
140	2	2	2 1/2	2 1/2	3	3	4
199	2	2 1/2	3	3	4	4	4

Note: Based on copper pipe and a 20°F Delta T with maximum water velocities of 4-1/2 ft per second

C. Piping Diagrams for Cascading Systems (continued)

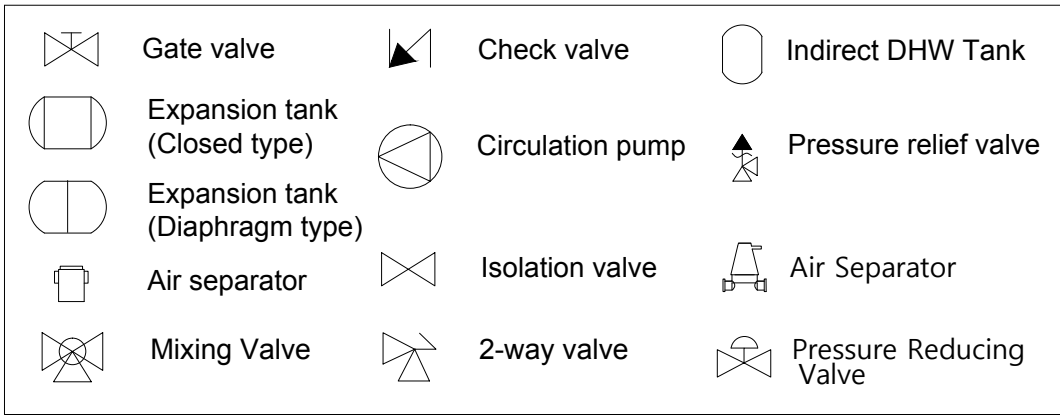

Piping Symbol Legend

Cascade System - Diaphragm type Expansion tank

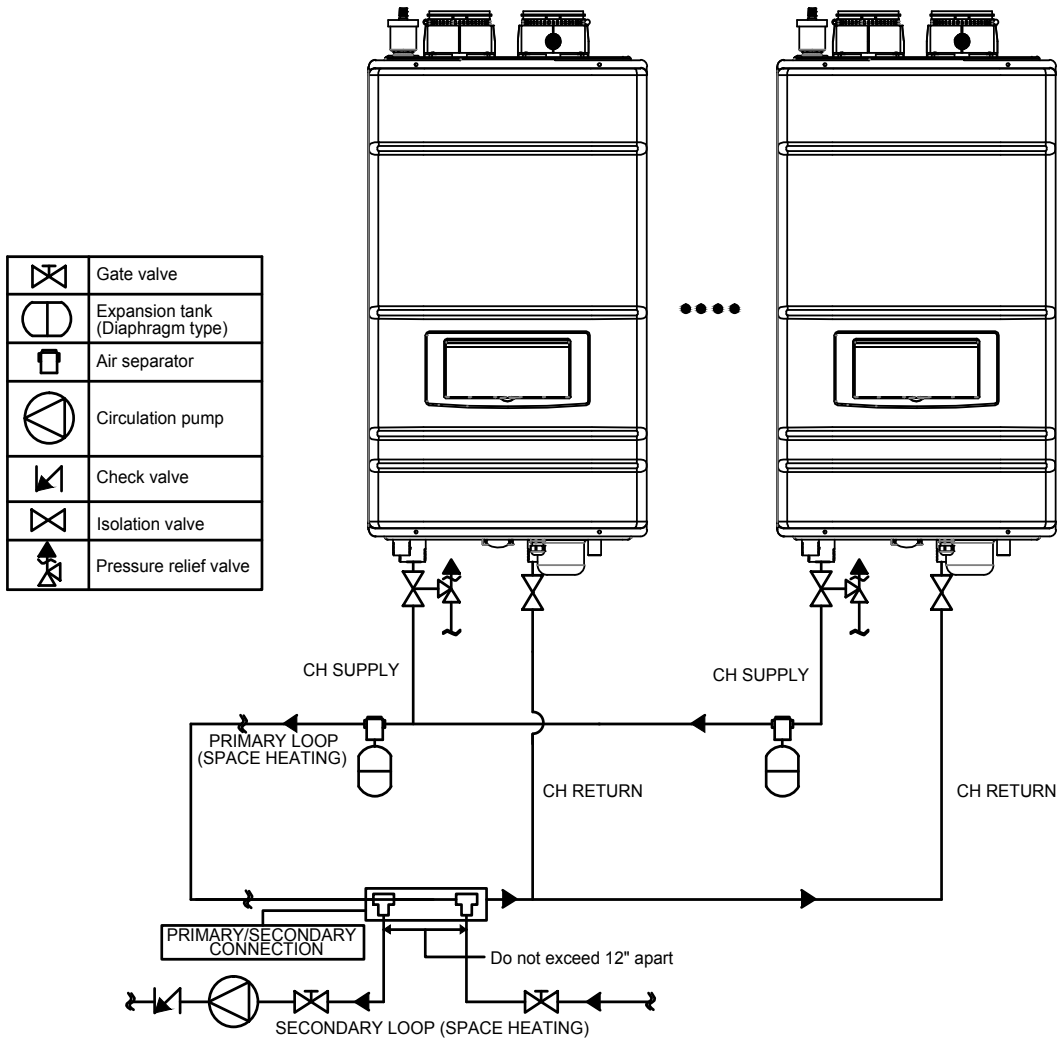

NOTE: These drawings are meant to show system piping concept only. Installer is responsible for all equipment and detailing required by local codes.

Cascade System - Zoning with circulation pump

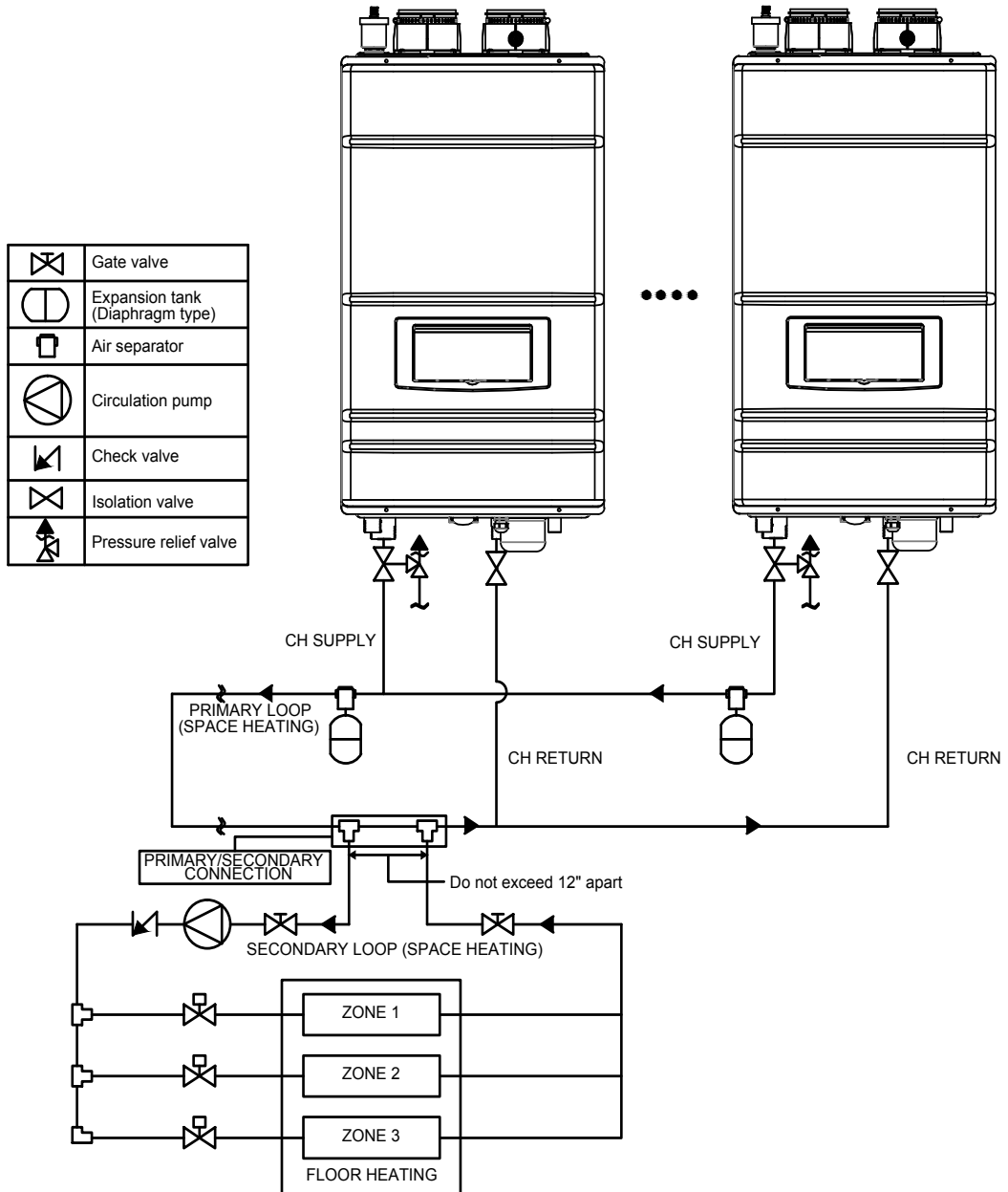

C. Piping Diagrams for Cascading Systems (continued)

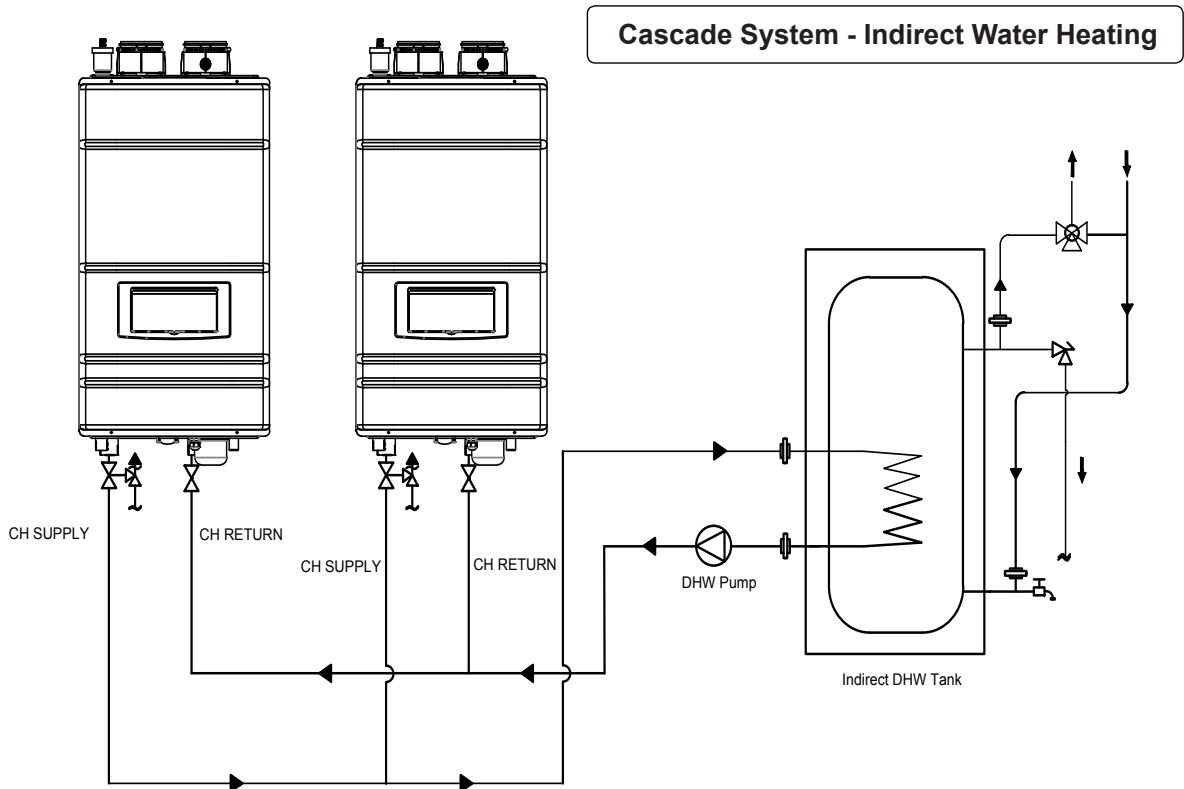
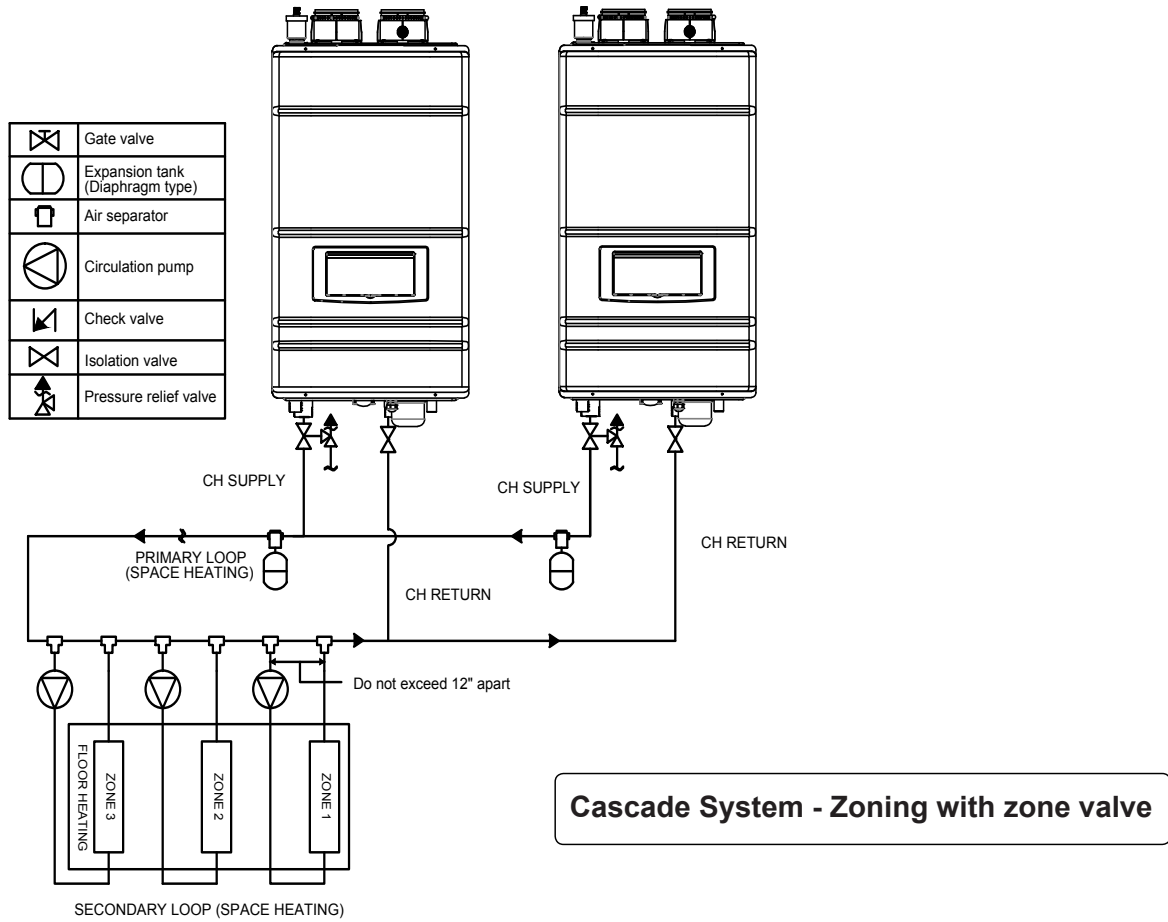

C. Piping Diagrams for Cascading Systems (continued)

Cascade System - System Application & DHW Tank

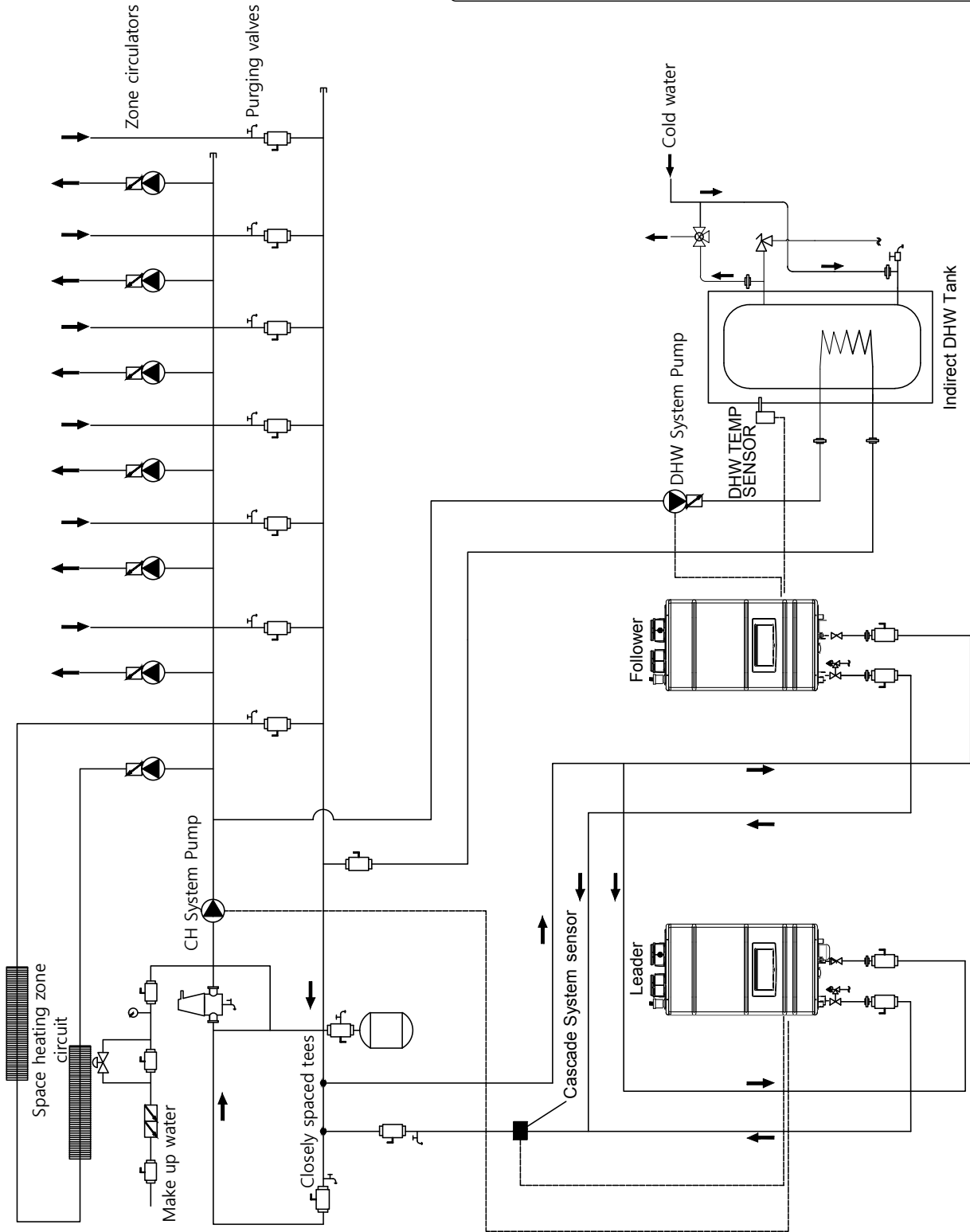

SECTION 2 Electrical

A. Wiring Connections for Cascade

A system sensor must be connected to the master boiler in order to provide feedback for set point temperature reference and therefore properly control the bank of cascaded boilers.

In order for the system to work properly, the thermostat, 0-10V signal, and/or outdoor sensor must be connected to the Leader boiler only. Following boilers will run based on the Leader boiler's controls.

Reference the FT Series Heating Only Installation and Operation manual (1342-NH) to set the Leader boiler's temperature set point based on an outdoor sensor, 0-10V signal or a fixed temperature set point.

Components Needed :

FT1868 : System Sensor (need only 1).

FT1861 : FT Series/ST Cascade Communication Cable (1 per unit) with Ending Resistor.

Example. If you are cascading 6 units, you will need **6 X FT1861's** and you will throw away 5 of the resistors.

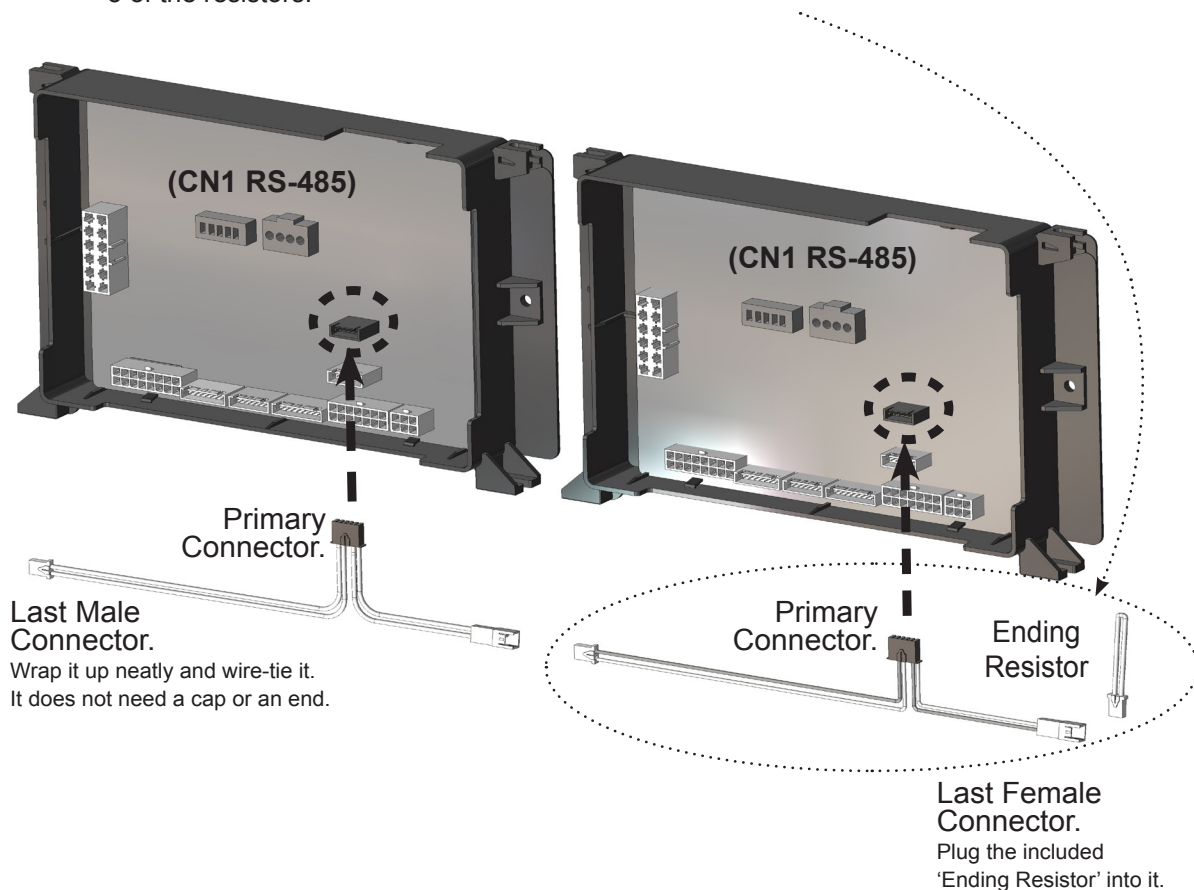

1. Turn off the power.
2. Remove the front covers of the units (4 screws on each unit).
3. Connect the 'Cascade Communication Cables' to every unit (add the Resistor to the end of the last follower. Use the wiring throughway at the bottom of each unit).
4. Plug the primary connector on the cable (as shown) to the receptacle inside the unit.
5. Replace the front covers.
6. Turn on the power.

B. Terminal Blocks

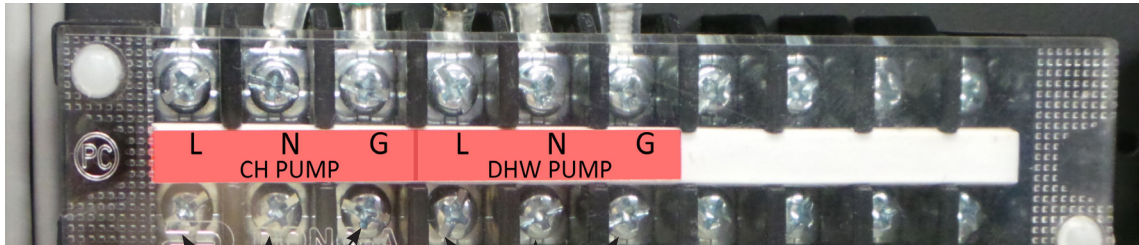

CH
PUMP

DHW
PUMP

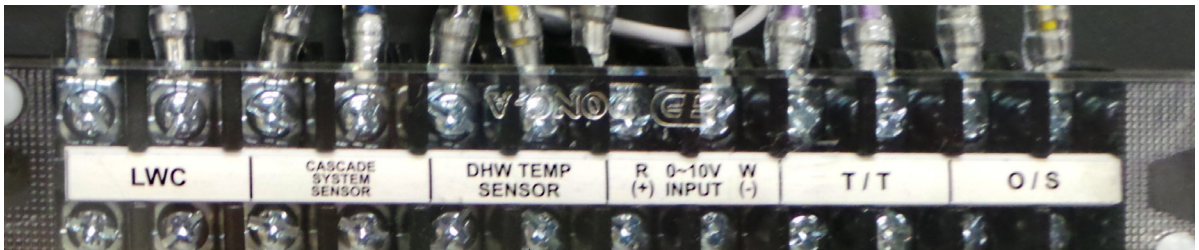

LOW
WATER
CUTOFF

CASCADE
SYSTEM
SENSOR

DHW
TEMP
SENSOR

0-10V
Connection

Thermostat
Connection

Outdoor
Sensor
Connection

SECTION 3 The Control Display

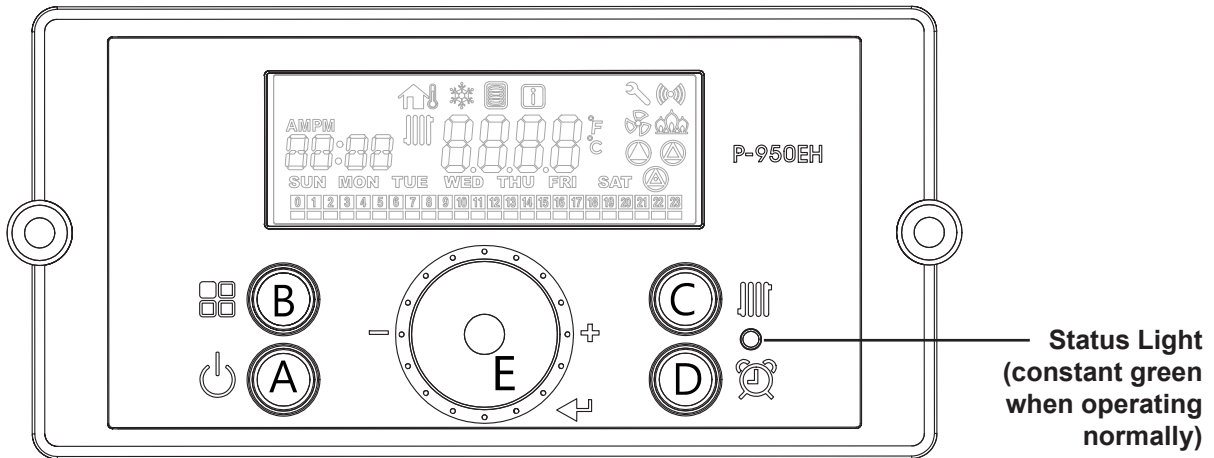

Status Light
(constant green
when operating
normally)

The Control Display has a Control Dial (E), 4 buttons (A, B, C, D), and a Liquid Crystal Display (with 72 back-lit segments). Section 3 will show you only a few of the functions of the FT Series. For all functions, please review the FT Series Install and Instruction Manual. Doc 1342.

Buttons			Functionality	
			PRESS (Tap)	PRESS and HOLD (5 seconds)
A		Display Power	Turns Control Display ON/OFF	
B		Modes	Tap to return to menu	(If Display Power was On) Status Display Mode (If Display Power was Off) Installer Mode
C		Heating Water	CH set-point change mode (Maximum 82°C(180°F))	
D		Time / Date Set	No Change	To SET: Year/Month/Week/Day/Time/Min
E		Scroll / Select	Menu select or value up(+)/down(-) or setting dial.	





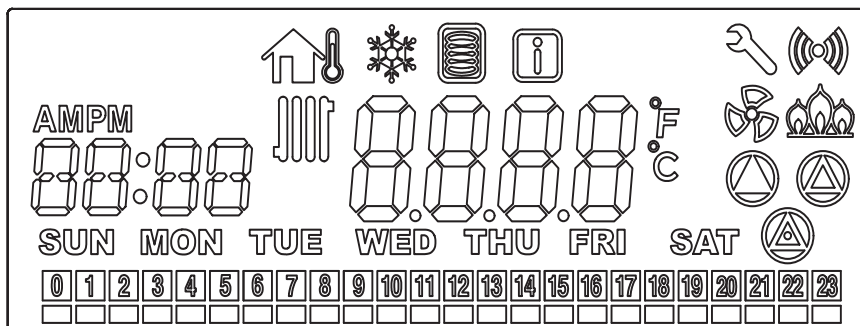













- Temperature Specifications
 Operating ambient Temperature Range : -10 to 60°C.
 Operating Relative Humidity up to: 90% at 40°C.
 Shipping & Storage Temperature Range of : -20 to 80°C.

B. The LCD



The LCD features a backlit lamp that will illuminate when a user presses a button. The display will time out after approximately 2 minutes.

B. The LCD (continued)

Symbol	Name	Description
	Service Reminder mode	Service Reminder mode indication
	Outside Temperature Mode	Outside Temp setting indication
	Anti-freeze mode	Anti-freeze mode indication
	Storage mode	Storage mode indication
	Information mode	Information mode indication
	Communication state	Communication state indication
	Time setting mode	Time /Dispaly/Install mode indication
	Fan operating mode	Fan operating mode indication
	Flame signal	Flame Signal indication
	CH pump mode	CH pump mode indication
	Storage pump mode	Storage pump mode indication
	Internal recirculation mode	Internal recirculation mode indication
	Celsius mode	Indicated as Celsius temperature
	Fahrenheit mode	Indicated as Fahrenheit temperature
	Heat demand mode	Heat demand mode indication
	DAY mode	Current day mode indication
	Cascade System connecting mode	Cascade System connecting mode indication
	Cascade System operating mode	Cascade System operating mode indication

C. Start-Up Sequence

After the appliance is powered ON, the LCD display shows a sequence of information. The icons will flash, followed by various indicators that describe the appliance controller and software versions. After start-up, the display appears as follows.

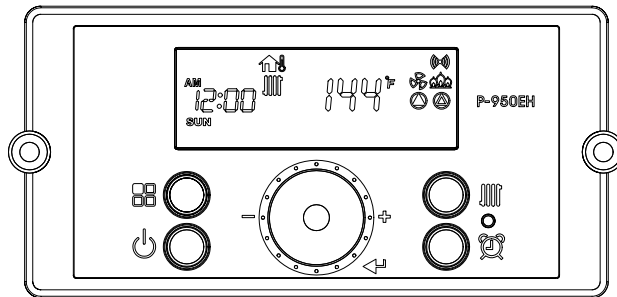

The Control Display can operate through user and service modes that have specific LCD outputs and dedicated controls, including:

- Changing the Set-Point Temperature
- Error Mode
- Status Display Mode
- Installer Mode



SECTION 4 Cascade Programming

A. Programming a Cascade System

Once all of the 'Connection Wires' are made and all units are powered on, there are 2 items that need to be programmed on all units. Start with the Lead Unit and then Repeat on all Following Units.

28: cP – (**PARAMETER**) The **TOTAL NUMBER** of units cascaded. Range: 01 - 20,

27: cn– (**NUMBER**) This is each unit's **ASSIGNED NUMBER**. Default 00. Range: 00 - 19 with 00 as the Leader, 01 (follower 1), 02 (follower 2), etc.

1. **START** by turning OFF the Power  to the Display Control.
2. Then, with the power OFF, Press and HOLD (5 seconds) the  button to get into the Installer Mode.

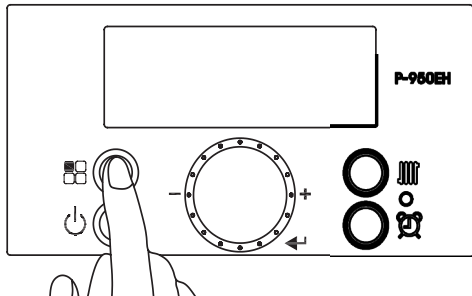

3. Rotate the Dial until you get to 28cP. Tap Dial E to enter into that Parameter.

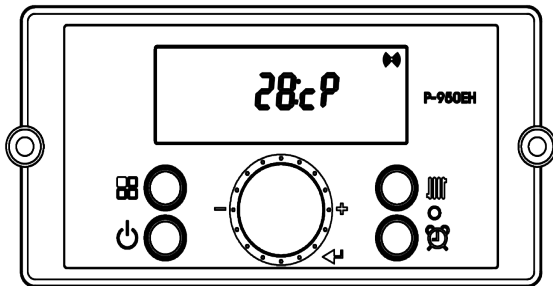

4. Adjust to the Total Number of Units in the Cascaded System. Range is Default at 01 and goes up to 20 units. then press (tap) the Dial to save and to Exit.

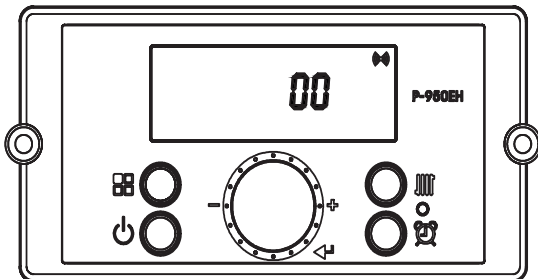

5. Then turn the dial to 27:Cn – Set the Number to 00. The Leader unit should always be addressed to 00. The Following units will then start at 01 and go sequentially from there.

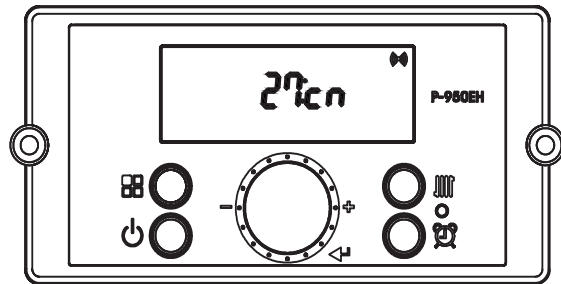

6. Finish by pressing the  button.

7. REPEAT steps 1 thru 6 with all following units in sequence.

NOTE: Do NOT change 29:Eh (Common Vent). This Installer Parameter must always be set to 'Off'.

8. When returning to the home screen, you will see properly addressed cascade units displayed in the bottom left corner. The address of each boiler is displayed in a box and a line underneath it indicates that it is firing. If there is no line under it, then it is not firing.

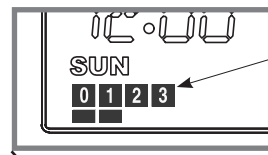

Example showing 4 boilers cascaded with 2 of them currently running.

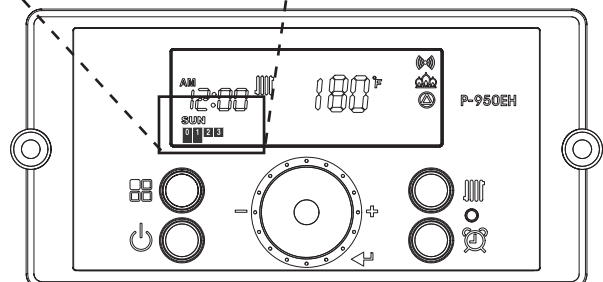



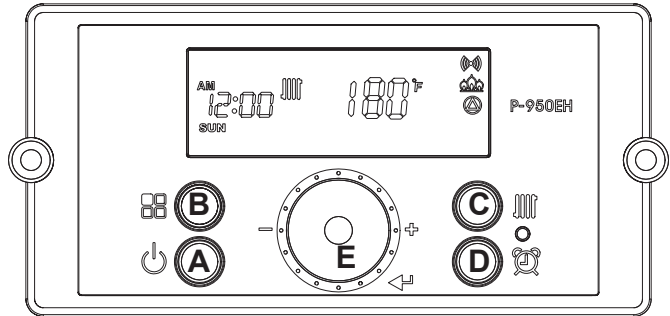

B. The Cascade CH Function

Changing the CHW Set-Point,

press the C  button. The CH Icon and current CH Setpoint will flash. Turn the E dial clockwise to increase, and counterclockwise to decrease CH setpoint, until desired temperature is reached. Press E dial to save changes and to Exit.



NOTE: When you set the temperature set point on the Leader Heating Only Boiler, it will automatically be applied to the followers.

Indicate	Indicator
Current CH Temperature Set-Point	
Celsius or Fahrenheit	°C or °F
If Communication state is activated	
If flame is detected	
Date and Time indicator	AM PM 88:88
If CH pump is operating	
If there currently a Demand for Central Heat (CH)	

Default CH set-point is 180°F (82°C)
 CH set-point range is 86°F ~180°F (30.0°C ~ 82.0°C)

1. The Leader unit controls all follower units' operation and combustion. All follower units follow what Leader unit outputs. (Operating temperature and clock will only be controlled on Leader unit , but displayed on Follower unit)
2. When Cascade is set for auto, the Leader boiler arranges which unit operates and for how long, when there is a call for heat (CH), the Leader boiler controls the follower units either to increase or reduce firing rate.
 * Installer mode 30: Cr -> Cr:at(Default)
3. When Cascade is set for cascade rotation time, the Leader boiler rotates the boilers based on a fixed operating time limit. Each boiler is run (when there is a call for heat) until it reaches the operating time limit, at which point the Leader boiler turns that boiler off and replaces it in the firing sequence with a boiler that has been off. In this way, the first boiler on will be the first boiler off, and that first boiler will not turn on again until the remaining boilers have each run for the operating time limit, as needed to meet demand.
 *Installer mode 30: Cr -> Cr:Ct
4. Cascade mode operates via system sensor. Units shut off when system sensor reaches system target temperature.
5. When each corresponding unit is operating the built in boiler pump operates. Also if a single unit is operating the external CH pump operates
6. Only the Leader unit needs to be wired to the boiler pump.

B. Cascade CH Function (continued)

Index Numbers		Parameter	Description
30:Cr	Cr:at	Automatic rotation (default)	The first unit to operate when there is a T/T call is the unit that ran the least amount of time during the prior heat calls (burner ON time). Default auto
	Cr:Ct	Cascade Rotation time	Cascade Rotation time, Range: 0-240 Hours, Default 48Hours
31: Ct		Cascade System temperature	Cascade System temperature: Range: 95°F – 180°F, Default 180°F
32: Cd		Cascade System Temperature Differential (burner ON)	Cascade System Temperature Differential (burner ON) Range: 5-30 °F, Default 10 °F

C. Domestic Hot Water ‘Storage Mode’ for Cascade System.

The boiler cascade system can be set up for Domestic Hot Water by using either a DHW Sensor or DHW Aquastats with a tank. Note that they are setup differently.

The default DHW priority time is 30 minutes and can be adjusted from 0 to 60 minutes using parameter 24: dP, see below parameter table.

Using a DHW Sensor

If a DHW sensor is used, the DHW Sensor leads must be connected to the Leader Boiler on the terminal strip labeled “DHW TEMP SENSOR” (page 9) and sensor installed in the tank.

In this mode the tank sensor will control demand and modulation based on the DHW setpoint (21:dh). In the case of indirect heaters the boiler will also modulate on the outlet water temperature sensor (25:st).

The DHW System Pump must be connected to the Leader Boiler (same boiler that the DHW sensor is connected to) on the terminal strip labeled “DHW Pump” (page 9).

Using Aquastats

If a DHW aquastat is used, the maximum DHW load needs to be calculated to determine the number of boilers required to meet max DHW load. The aquastat must be installed in the tank and wired to each boilers’ terminal strip “DHW TEMP SENSOR” connection (page 9). Wire the boilers in series with the aquastat: aquastat to first boiler and then from boiler to boiler.

The DHW System Pump must be connected to the first boiler among those selected to handle the domestic water load on the terminal strip labeled “DHW Pump” (page 9).

C. Domestic Hot Water 'Storage Mode' for Cascade System (continued)

Domestic Hot Water Parameters

For a complete list of parameters, reference the FT Series Installation and Operation Manual 1342.

Index Numbers	Parameter	Description
21: dH	Indirect Storage Tank Temperature Set Point	Sets Maximum Indirect storage tank Temperature Range: 95 - 180°F , Default 120 °F
22: dd	Indirect Storage Tank Differential Set Point	DHW Differential Set Point Range: 5°F-30°F, Default 7 °F
23: Pr	DHW Pump Post Run Time	DHW Pump Post Run Time Range: 0-10 Min, Default 1 Min
24: dP	DHW Priority Timer	DHW Priority Timer Range: 0 – 60 Min , Default 30 Min
25: St	Boiler Supply Indirect Storage Tank Temperature	Boiler Supply Indirect Tank Temperature Range: 120 °F– 180 °F , Default 180 °F

D. Cascade System Error Codes

For a complete list of error codes, reference the FT Series Installation and Operation Manual 1342.

Er:30	System Sensor Short	<p>NOTE: This error will only appear if the boiler is used in a cascaded system.</p> <p>This Error Code will go away when system sensor is repaired or replaced.</p> <ol style="list-style-type: none"> 1. Check system temperature sensor. Ensure connections are secure. 2. Check system sensor resistance. If resistance is zero, replace the sensor. 3. If the problem persists, replace the main control. <p>NOTE: During the error state the units will continue to operate. Boiler setpoint will be the same as the system sensor setpoint until the issue is remedied. During normal operation boiler setpoint is defaulted to 20°F higher than the system setpoint to a maximum of 180°F setting</p>
Er:78	Cascade Communication Error	<p>NOTE: This error will only appear in a cascaded system.</p> <ol style="list-style-type: none"> 1. Turn power OFF and ON at the boiler display panel. 2. If error reappears, ensure all cascaded boilers are powered ON. 3. If error reappears, check Installer Mode parameter 28 at the Leader boiler. Ensure the number of cascaded units chosen in this parameter matches the number of cascaded units in the system. 4. If error reappears, check Installer Mode parameter 27 at all cascaded boilers. Ensure the address number matches that of the connected boiler (00 for Leader, 01 for Follower 1, etc.) and that no numbers are skipped or repeated. 5. Ensure every unit in the cascade system is connected properly. Inspect the cascade cables and ensure all are connected without damage or defect. Repair or replace any damaged cables. 6. If the problem persists, replace the main control.

Notes:

Notes:																									

H2384200B



Customer Service and Product Support: 800.900.9276 • Fax 800.559.1583
20 Industrial Way, Rochester, NH, USA 03867