

# Webstone

**VALVE INNOVATION**

THE **ONLY** WAY TO INSTALL  
ANY **TANKLESS**  
**WATER HEATER**

**PATENTED TECHNOLOGY**

The ISOLATOR<sup>®</sup>  
**E·X·P**  
TWH SERVICE VALVES





# THE ORIGINAL TANKLESS WATER HEATER SERVICE VALVES

- Heavy duty forged brass valves with full port main flow channel & drain
- Hi-flow full port 3/4" drain offers the greatest flow rate
- 304 Stainless steel wing handle for easy actuation of the main ball
- Color coded insulator rings for easy identification of hot & cold valves
- Aluminum handle for easy actuation of the drain ball
- Available in threaded or sweat connections
- Available with or without a pressure relief valve
- Available with lead-free CleanBrass construction for compliance with AB1953, NSF/ANSI 61-G & NSF 372
- **GUARANTEED FOR LIFE**

## PATENTED TECHNOLOGY

### ISOLATOR® E-X-P™ TANKLESS WATER HEATER SERVICE VALVE KIT

Hot & Cold Set of Full Port Forged Brass Ball Valves  
w/ Hi-Flow Hose Drains, Pressure Relief Valve Outlet & Adjustable Packing Glands

CONFORMS TO NSF/ANSI 61-8  
600 WOG • ISO 9001

	ITEM #	LEAD-FREE ITEM # CERTIFIED TO NSF/ANSI 61-G	SIZE	CTN/CASE	A	B	C	D	E	F	G
<b>IPS UNION x IPS</b>	40443	40443W	3/4"	1/8	3/4	4 15/16	1 1/2	1 13/16	2 7/8	3/4	3/4
<b>IPS UNION x SWT</b>	50443	50443W	3/4"	1/8	3/4	4 15/16	1 1/2	1 13/16	2 7/8	3/4	3/4

### INCLUDES RESIDENTIAL PRESSURE RELIEF VALVE (150 PSI/200,000 BTU)

<b>IPS UNION x IPS</b>	40443PR	40443WPR	3/4"	1/8	3/4	4 15/16	1 1/2	1 13/16	2 7/8	3/4	3/4
<b>IPS UNION x SWT</b>	50443PR	50443WPR	3/4"	1/8	3/4	4 15/16	1 1/2	1 13/16	2 7/8	3/4	3/4

### INCLUDES COMMERCIAL PRESSURE RELIEF VALVE (150 PSI/2,703,000 BTU) & 3/4" CLOSE NIPPLE

<b>IPS UNION x IPS</b>	40443PR2	40443WPR2	3/4"	1/6	3/4	4 15/16	1 1/2	1 13/16	2 7/8	3/4	3/4
<b>IPS UNION x SWT</b>	50443PR2	50443WPR2	3/4"	1/6	3/4	4 15/16	1 1/2	1 13/16	2 7/8	3/4	3/4

## AVAILABLE AS:



- **CHOICE OF IPS OR SWT EXP TWH SERVICE VALVES**
- **200,000 BTU PRESSURE RELIEF VALVE**
- **24" x 3/4" GAS FLEX LINE**
- **3/4" CGA GAS BALL VALVE**

	ITEM #	LEAD-FREE ITEM # CERTIFIED TO NSF/ANSI 61-G
<b>IPS ISOLATOR® E-X-P™ Complete</b>	40443COM	40443WCOM
<b>SWT ISOLATOR® E-X-P™ Complete</b>	50443COM	50443WCOM

NEED A CUSTOM KIT? CALL OUR SALES PROFESSIONALS AT (800) 225-9529 TO DESIGN A KIT TO MEET YOUR SPECIFIC NEEDS.

LEAD FREE  
**CLEAN  
 BRASS**<sup>™</sup>  
 THE CLEAR CHOICE  
 FOR THE PROFESSIONAL

Available with lead-free  
 CleanBrass construction for  
 compliance with AB1953,  
 NSF/ANSI 61-G & NSF 372

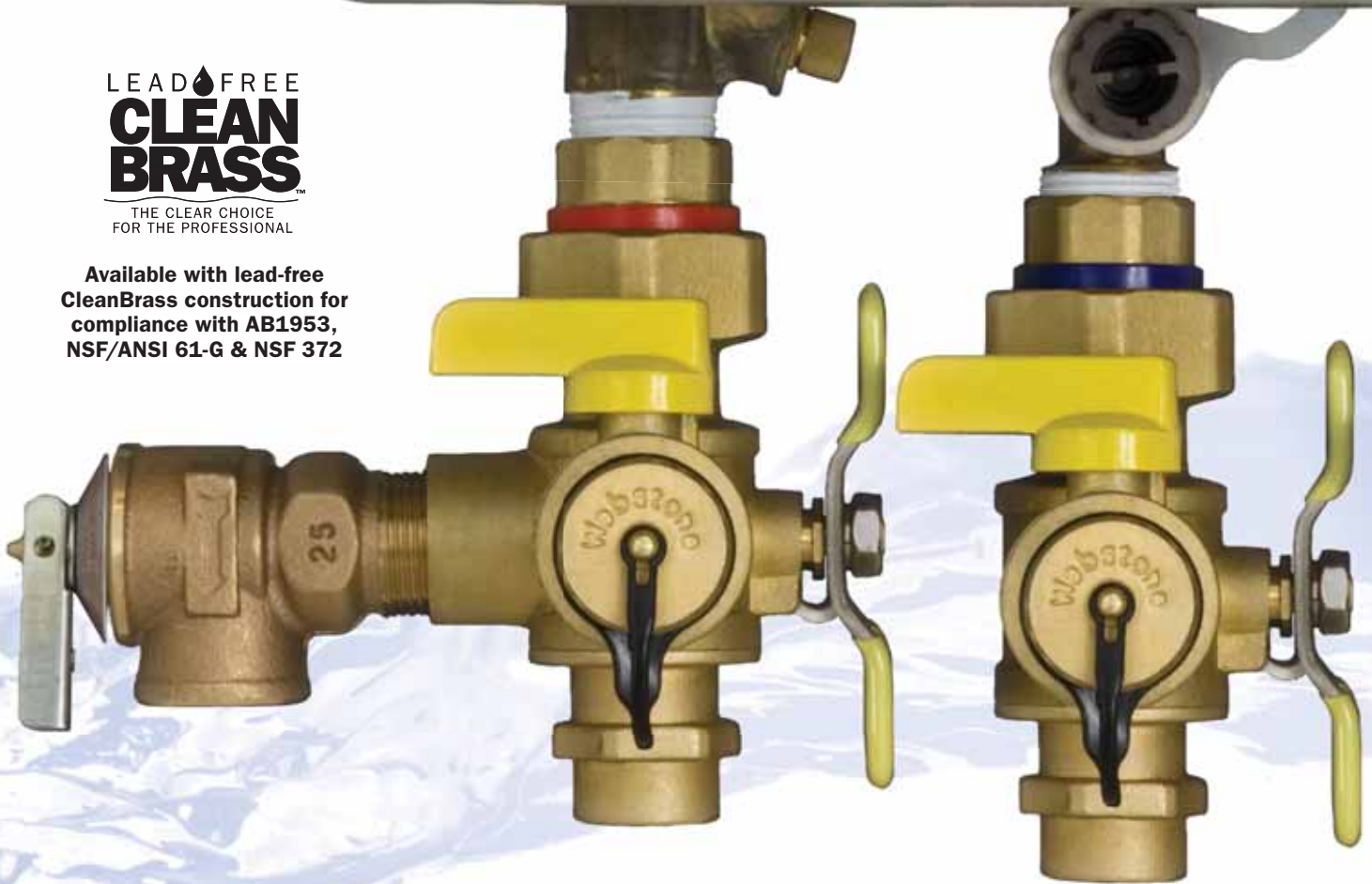

NO.	DESCRIPTION	MATERIAL
1	BODY	BRASS
2	END CAP	BRASS
3	SEAT	PTFE
4	BALL	BRASS HCP
5	STEM	BRASS
6	STEM SEAL	PTFE
7	PACKING GLAND	BRASS
8	HANDLE NUT	STAINLESS STEEL
9	WING STYLE "T" HANDLE	STAINLESS STEEL
10	HANDLE JACKET	VINYL
11	LOCK WASHER	STAINLESS STEEL
12	UNION WASHER	EPDM
13	COLOR ED INSULATOR RING	ABS
14	UNION NUT	BRASS
15	UNION FITTING	BRASS
16	RETAINING SEATS	PTFE
17	DRAIN VALVE HANDLE	ENAMEL COATED ALUMINUM
18	DRAIN VALVE HANDLE SCREW	BRASS
19	RETAINING NUT	BRASS
20	CAP & STRAP	BRASS W/ EPDM HOSE WASHER

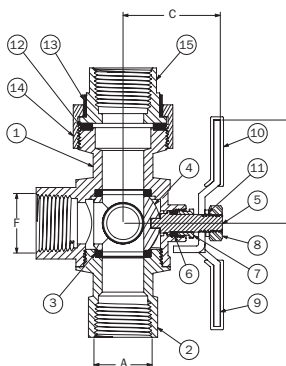

HOT

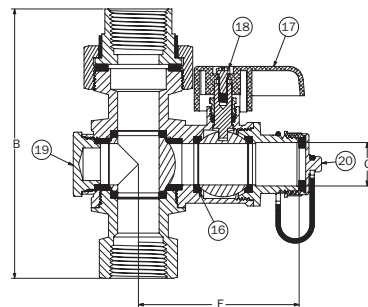

COLD

RESIDENTIAL PRESSURE  
 RELIEF VALVE

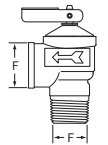

COMMERCIAL PRESSURE  
 RELIEF VALVE  
 & 3/4" CLOSE NIPPLE

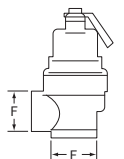

# The ISOLATOR<sup>®</sup> E·X·P E2 TWH SERVICE VALVES

## COMPACT VERSION OF OUR ORIGINAL ISOLATOR E-X-P

- Heavy duty forged brass valves with full port main flow channel
- Uniquely designed lever/wing handle for easy actuation of the main ball
- Color coded aluminum handles for easy identification of hot & cold valves
- Large drain port outlets
- Available in threaded & sweat connections
- Available with your choice of three different pressure relief valves
- Available with lead-free CleanBrass construction for compliance with AB1953, NSF/ANSI 61-G & NSF 372
- **GUARANTEED FOR LIFE**

### PATENTED TECHNOLOGY

#### ISOLATOR<sup>®</sup> E-X-P E2™ TANKLESS WATER HEATER SERVICE VALVE KITS

Hot & Cold Set of Full Port Forged Brass Ball Valves w/ Hi-Flow Hose Drains, Pressure Relief Valve Outlet & Adjustable Packing Glands

CONFORMS TO NSF/ANSI 61-8  
500 WOG

#### INCLUDES RESIDENTIAL PRESSURE RELIEF VALVE (150 PSI/200,000 BTU)

	ITEM #	LEAD-FREE ITEM # CERTIFIED TO NSF/ANSI 61-G	SIZE	CTN/CASE	A	B	C	D	E	F	G
<b>IPS UNION × IPS</b>	44443PR	44443WPR	3/4"	1/10	3/4	4 1/4	1 5/8	2 5/8	2 3/4	3/4	1/2
	44444PR	44444WPR	1"	1/10	1	5	2 3/8	2 3/8	2 3/4	3/4	3/4
<b>IPS UNION × SWT</b>	54443PR	54443WPR	3/4"	1/10	3/4	4 3/4	1 5/8	2 5/8	2 3/4	3/4	1/2
	54444PR	54444WPR	1"	1/10	1	5 1/8	2 3/8	2 3/8	2 3/4	3/4	3/4

#### INCLUDES RESIDENTIAL PRESSURE RELIEF VALVE (30 PSI/510,000 BTU)

<b>IPS UNION × IPS</b>	44443PR3	44443WPR3	3/4"	1/10	3/4	4 1/4	1 5/8	2 5/8	2 3/4	3/4	1/2
	44444PR3	44444WPR3	1"	1/10	1	5	2 3/8	2 3/8	2 3/4	3/4	3/4
<b>IPS UNION × SWT</b>	54443PR3	54443WPR3	3/4"	1/10	3/4	4 3/4	1 5/8	2 5/8	2 3/4	3/4	1/2
	54444PR3	54444WPR3	1"	1/10	1	5 1/8	2 3/8	2 3/8	2 3/4	3/4	3/4

#### INCLUDES COMMERCIAL PRESSURE RELIEF VALVE (150 PSI/2,703,000 BTU) & 3/4" CLOSE NIPPLE

<b>IPS UNION × IPS</b>	44443PR2	44443WPR2	3/4"	1/6	3/4	4 1/4	1 5/8	2 5/8	2 3/4	3/4	1/2
	44444PR2	44444WPR2	1"	1/6	1	5	2 3/8	2 3/8	2 3/4	3/4	3/4
<b>IPS UNION × SWT</b>	54443PR2	54443WPR2	3/4"	1/6	3/4	4 3/4	1 5/8	2 5/8	2 3/4	3/4	1/2
	54444PR2	54444WPR2	1"	1/6	1	5 1/8	2 3/8	2 3/8	2 3/4	3/4	3/4

#### AVAILABLE AS:

The ISOLATOR<sup>®</sup>  
E·X·P  
TWH SERVICE VALVES  
**COMPLETE**



- **CHOICE OF IPS OR SWT E2 TWH SERVICE VALVES**
- **200,000 BTU PRESSURE RELIEF VALVE**
- **24" × 3/4" GAS FLEX LINE**
- **3/4" CGA GAS BALL VALVE**

	ITEM #	LEAD-FREE ITEM # CERTIFIED TO NSF/ANSI 61-G
<b>IPS ISOLATOR<sup>®</sup> E-X-P™ E2 Complete</b>	44443COM	44443WCOM
<b>SWT ISOLATOR<sup>®</sup> E-X-P™ E2 Complete</b>	54443COM	54443WCOM

NEED A CUSTOM KIT? CALL OUR SALES PROFESSIONALS AT (800) 225-9529 TO DESIGN A KIT TO MEET YOUR SPECIFIC NEEDS.

LEAD FREE  
**CLEAN BRASS**<sup>™</sup>  
 THE CLEAR CHOICE  
 FOR THE PROFESSIONAL

Available with lead-free  
 CleanBrass construction for  
 compliance with AB1953,  
 NSF/ANSI 61-G & NSF 372

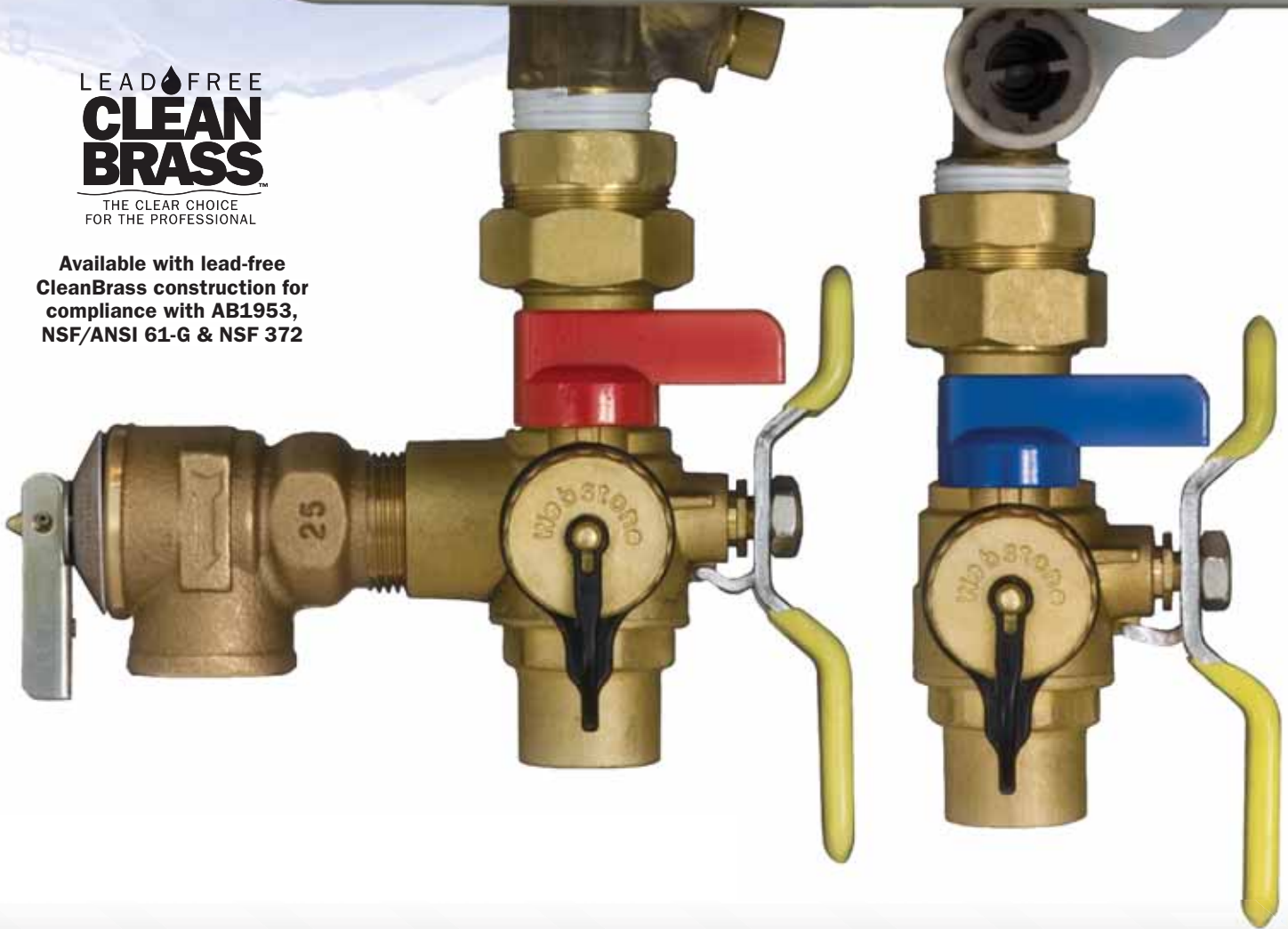

NO.	DESCRIPTION	MATERIAL
1	BODY	BRASS
2	SEATS	PTFE
3	BALL	BRASS HCP
4	HANDLE NUT	STAINLESS STEEL
5	WING STYLE "T" HANDLE	STEEL CP
6	HANDLE JACKET	VINYL
7	PACKING GLAND	BRASS
8	STEM SEAL	PTFE
9	STEM	BRASS
10	END CAP	BRASS
11	UNION NUT	BRASS
12	RETAINING RING	STAINLESS STEEL
13	UNION FITTING	BRASS
14	WASHER	EPDM
15	DRAIN VALVE HANDLE	ENAMEL COATED ALUMINUM
16	DRAIN VALVE HANDLE SCREW	BRASS
17	CAP & STRAP	BRASS W/ EPDM HOSE WASHER

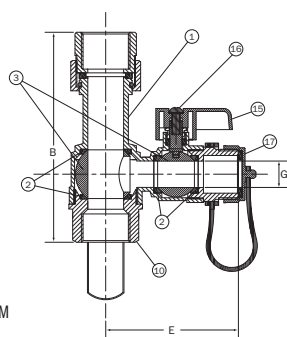

DRAIN

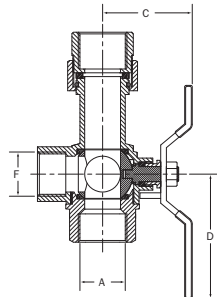

HOT

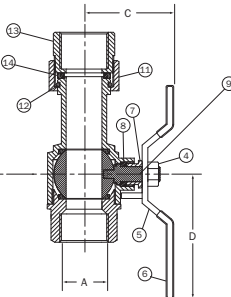

COLD

RESIDENTIAL PRESSURE  
 RELIEF VALVE

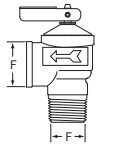

COMMERCIAL PRESSURE  
 RELIEF VALVE  
 & 3/4" CLOSE NIPPLE

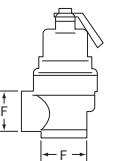

# The ISOLATOR® E·X·P E3 TWH SERVICE VALVES

## COMPACT VERSION OF OUR ORIGINAL ISOLATOR E-X-P WITH AN ADJUSTABLE PRESSURE RELIEF VALVE OUTLET

- Adjustable pressure relief valve fitting for use with pipe covers & recessed boxes
- Heavy duty forged brass valves with full port main flow channel
- Uniquely designed lever/wing handle for easy actuation of the main ball
- Color coded aluminum handles for easy identification of hot & cold valves
- Large drain port outlets
- Available in threaded & sweat connections
- Available with your choice of three different pressure relief valves
- Available with lead-free CleanBrass construction for compliance with AB1953, NSF/ANSI 61-G & NSF 372
- **GUARANTEED FOR LIFE**

### PATENTED TECHNOLOGY

#### ISOLATOR® E-X-P E3™ TANKLESS WATER HEATER SERVICE VALVE KITS

Hot & Cold Set of Full Port Forged Brass Ball Valves w/ Hi-Flow Hose Drains, Adjustable Pressure Relief Valve Outlet & Adjustable Packing Glands

CONFORMS TO NSF/ANSI 61-8  
500 WOG

#### INCLUDES RESIDENTIAL PRESSURE RELIEF VALVE (150 PSI/200,000 BTU)

	ITEM #	LEAD-FREE ITEM # CERTIFIED TO NSF/ANSI 61-G	SIZE	CTN/CASE	A	B (COLD)	B (HOT)	C	D	E	F	G
<b>IPS UNION x IPS</b>	45443PR	45443WPR	3/4"	1/10	3/4	4 1/4	5 7/8	1 5/8	2 5/8	2 3/4	3/4	1/2
<b>IPS UNION x SWT</b>	55443PR	55443WPR	3/4"	1/10	3/4	4 3/4	6 3/8	1 5/8	2 5/8	2 3/4	3/4	1/2

#### INCLUDES RESIDENTIAL PRESSURE RELIEF VALVE (30 PSI/510,000 BTU)

<b>IPS UNION x IPS</b>	45443PR3	45443WPR3	3/4"	1/10	3/4	4 1/4	5 7/8	1 5/8	2 5/8	2 3/4	3/4	1/2
<b>IPS UNION x SWT</b>	55443PR3	55443WPR3	3/4"	1/10	3/4	4 3/4	6 3/8	1 5/8	2 5/8	2 3/4	3/4	1/2

#### INCLUDES COMMERCIAL PRESSURE RELIEF VALVE (150 PSI/2,703,000 BTU) & 3/4" CLOSE NIPPLE

<b>IPS UNION x IPS</b>	45443PR2	45443WPR2	3/4"	1/6	3/4	4 1/4	5 7/8	1 5/8	2 5/8	2 3/4	3/4	1/2
<b>IPS UNION x SWT</b>	55443PR2	55443WPR2	3/4"	1/6	3/4	4 3/4	6 3/8	1 5/8	2 5/8	2 3/4	3/4	1/2

#### AVAILABLE AS:

The ISOLATOR®  
**E·X·P**  
TWH SERVICE VALVES  
**COMPLETE**



- **CHOICE OF IPS OR SWT E3 TWH SERVICE VALVES**
- **200,000 BTU PRESSURE RELIEF VALVE**
- **24" x 3/4" GAS FLEX LINE**
- **3/4" CGA GAS BALL VALVE**

	ITEM #	LEAD-FREE ITEM # CERTIFIED TO NSF/ANSI 61-G
<b>IPS ISOLATOR® E-X-P™ E3 Complete</b>	45443COM	45443WCOM
<b>SWT ISOLATOR® E-X-P™ E3 Complete</b>	55443COM	55443WCOM

NEED A CUSTOM KIT? CALL OUR SALES PROFESSIONALS AT (800) 225-9529 TO DESIGN A KIT TO MEET YOUR SPECIFIC NEEDS.

**A PERFECT FIT FOR INSTALLATION  
IN RECESSED BOXES  
OR OTHER TIGHT QUARTERS**

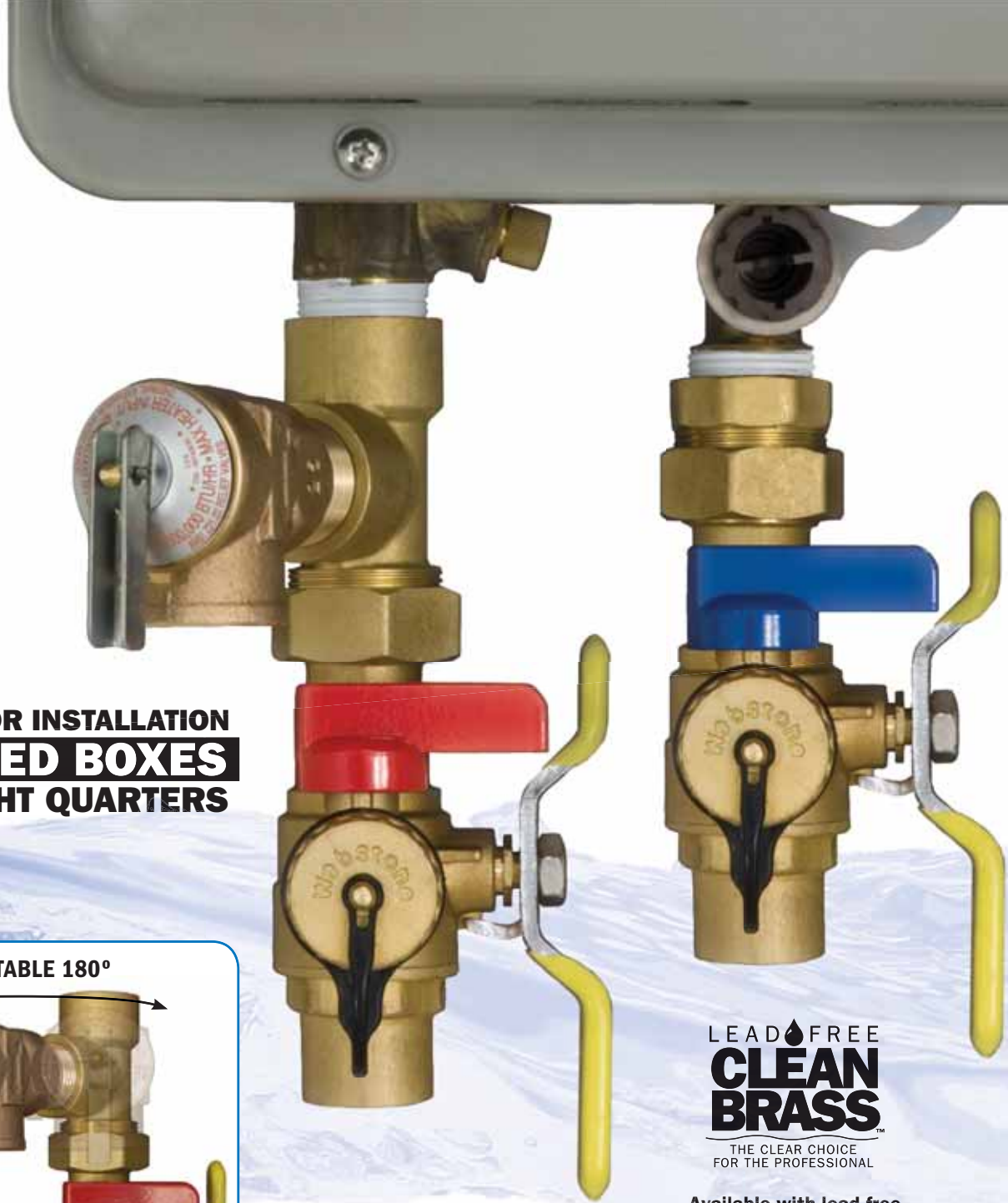

**ADJUSTABLE 180°**

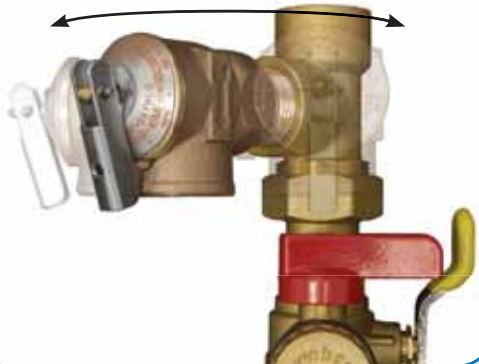

**LEAD FREE  
CLEAN  
BRASS™**

THE CLEAR CHOICE  
FOR THE PROFESSIONAL

Available with lead-free  
CleanBrass construction for  
compliance with AB1953,  
NSF/ANSI 61-G & NSF 372

NO.	DESCRIPTION	MATERIAL
1	BODY	BRASS
2	SEATS	PTFE
3	BALL	BRASS HCP
4	HANDLE NUT	STAINLESS STEEL
5	WING STYLE "T" HANDLE	STEEL CP
6	HANDLE JACKET	VINYL
7	PACKING GLAND	BRASS
8	STEM SEAL	PTFE
9	STEM	BRASS
10	END CAP	BRASS
11	UNION NUT	BRASS
12	RETAINING RING	STAINLESS STEEL
13	UNION FITTING	BRASS
14	WASHER	EPDM
15	DRAIN VALVE HANDLE	ENAMEL COATED ALUMINUM
16	DRAIN VALVE HANDLE SCREW	BRASS
17	CAP & STRAP	BRASS W/ EPDM HOSE WASHER
18	RELOCATION ADAPTER (HOT)	BRASS

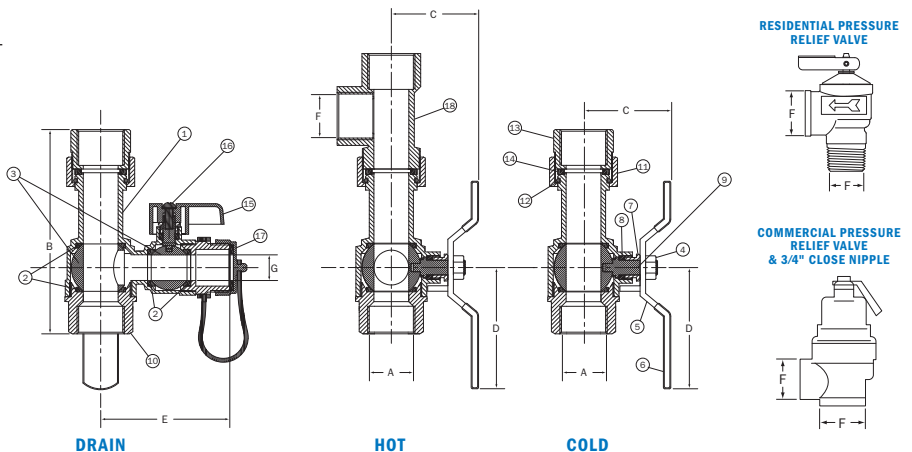

# The ISOLATOR<sup>®</sup> E·X·P<sup>™</sup> TWH SERVICE VALVES

## ADVANTAGES

- Quicker, consistent quality installation
- Fewer leak paths
- Allows for easy cleaning or flushing of system
- Allows for one person diagnostic testing of water heater unit
- **GUARANTEED FOR LIFE**

### NORMAL OPERATION

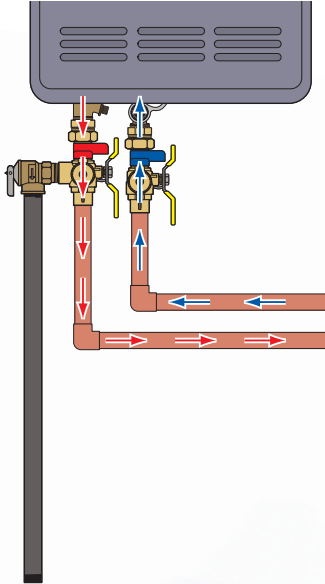

### CLEANING

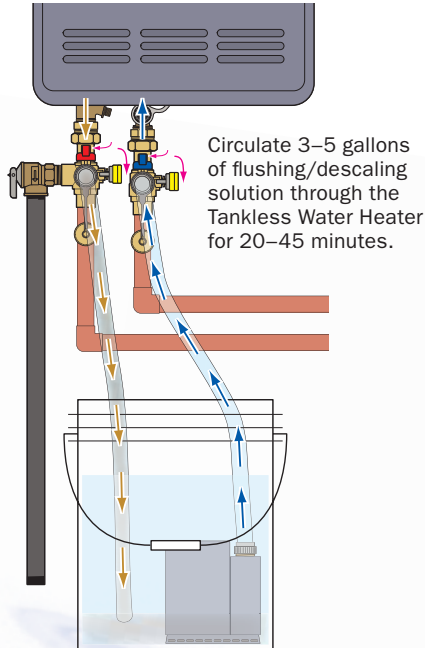

### FLUSHING

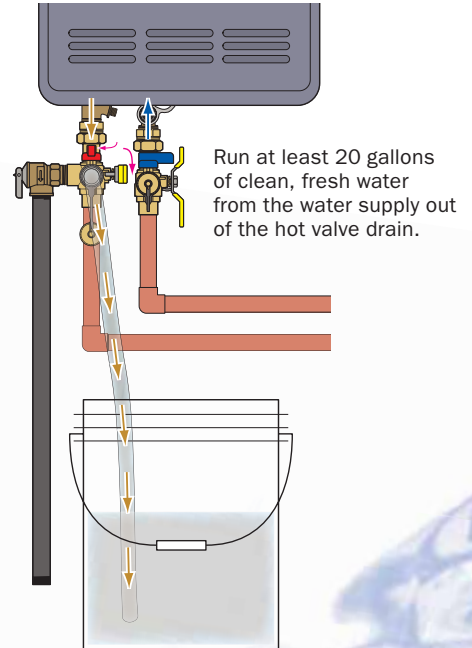

## ISOLATOR<sup>®</sup> E-X-P<sup>™</sup> ACCESSORIES AVAILABLE TO MAKE **YOUR JOB EASIER**



#### RELOCATION ADAPTER KITS

Use this kit to relocate the direction of the pressure relief valve in recessed boxes, tight or unique installations

FITS	ITEM #	LEAD FREE ITEM# CERTIFIED TO NSF/ANSI 61-G	SIZE	CTN/CASE	WT/CASE
EXP	28003	-	3/4"	1/100	85
E2	28023	28023W	3/4"	1/100	55

#### 1/2" UNION ADAPTER KITS

Use these kits to change the inlet connection of your service valves from 3/8" to 1/2"

FITS	ITEM #	LEAD FREE ITEM# CERTIFIED TO NSF/ANSI 61-G	SIZE	CTN/CASE	WT/CASE
ALL MODELS	29032	29032W	3/4" x 1/2"	BULK	BULK

#### PRESSURE RELIEF VALVES

##### RESIDENTIAL PRESSURE RELIEF VALVES

	ITEM #	LEAD FREE ITEM# CERTIFIED TO NSF/ANSI 61-G	SIZE	CTN/CASE	WT/CASE
150 PSI/200,000 BTU	20713	20713W	3/4"	1/100	49
30 PSI/510,000 BTU	20733	-	3/4"	1/100	49

##### COMMERCIAL PRESSURE RELIEF VALVES (Requires close nipple # 29003)

	ITEM #	LEAD FREE ITEM# CERTIFIED TO NSF/ANSI 61-G	SIZE	CTN/CASE	WT/CASE
150 PSI/2.7 MILLION BTU	20723	-	3/4"	1/24	31
CLOSE NIPPLE	29003	-	3/4"	BULK	BULK



FORM #: EXP0912

The Isolator EXP is a registered trademark of Webstone. This content has been provided for the express purpose of demonstrating a product's function in a system and should not be used as a substitute for professional advice. All products are used and all systems are designed in accordance with all applicable federal, state and local codes.

**Webstone**  
VALVE INNOVATION

ONE APPIAN WAY WORCESTER, MA 01610  
P.O. BOX 59 WORCESTER, MA 01613  
P: (800) 225-9529 · F: (800) 336-5133  
[www.webstonevalves.com](http://www.webstonevalves.com)